



# HIT-RE 500 V3 INJECTION MORTAR

**Technical Datasheet**

Update: Jul-20





# HIT-RE 500 V3 injection mortar

Anchor design (EN 1992-4) / Rods&Sleeves / Concrete

## Injection mortar system



Foil pack: HIT-RE 500 V3  
(available in 330, 500 and 1400 ml cartridges)



Anchor rod:  
HAS-U  
HAS-U HDG  
HAS-U A4  
HAS-U HCR  
AM 8.8 (HDG)  
(M8-M39)



Internally threaded sleeve:  
HIS-N  
HIS-RN  
(M8-M20)

## Benefits

- **SafeSet** technology: Simplified method of borehole preparation using either Hilti hollow drill bit for hammer drilling or Roughening tool for diamond cored applications
- Suitable for cracked/non-cracked concrete C 20/25 to C 50/60
- High loading capacity
- Suitable for dry and water saturated concrete
- Hilti Technical Data for under water application
- High corrosion resistance
- Long working time at elevated temperatures
- Cures down to -5°C
- Odourless epoxy

## Base material



Concrete (non-cracked)



Concrete (cracked)

## Installation conditions

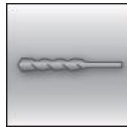

Hammer drilled holes



Diamond drilled holes

**SAFE-SET**

Hilti **SafeSet** technology

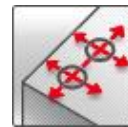

Small edge distance and spacing

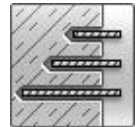

Variable embedment depth

## Load conditions

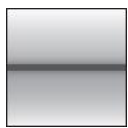

Static/  
quasi-static



Seismic,  
ETA-C1, C2



Fire  
resistance

## Other information



European  
Technical  
Assessment



CE conformity



PROFIS  
design  
Software

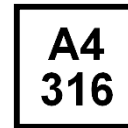

Corrosion  
resistance



High  
corrosion  
resistance <sup>a)</sup>

a) Applications only with HAS-U anchor rods

## Approvals / certificates

Description	Authority / Laboratory	No. / date of issue
European Technical Assessment <sup>a)</sup>	CSTB	ETA-16/0143 / 2019-05-14
Shockproof fastenings in civil defence installations	Federal Office for Civil Protection, Bern	BZS D 16-601/ 2016-08-31
Fire test report <sup>b)</sup>	MFPA Leipzig	GS 3.2/15-361-4 / 2016-08-04

a) All data given in this section according to ETA-16/0143, issue 2019-05-14.

b) Fire test report only available for HAS-U rods.

## Static and quasi-static resistance (for a single anchor)

### All data in this section applies to:

- Correct setting (See setting instruction)
- No edge distance and spacing influence
- **Steel** failure
- HAS-U anchor rod with strength class 5.8 and 8.8, AM anchor rod with strength class 8.8, HIS-N internally threaded insert with screw 8.8
- Base material thickness, as specified in the table
- Concrete C 20/25,  $f_{ck,cube} = 25 \text{ N/mm}^2$
- Temperature range I:  $-40 \text{ }^\circ\text{C}$  to  $+40 \text{ }^\circ\text{C}$   
(min. base material temperature  $-40^\circ\text{C}$ , max. long/short term base material temperature:  $+24^\circ\text{C}/40^\circ\text{C}$ )
- Short term loading. For long term loading please apply  $\psi_{sus}$ .
  - Hammer drilled holes, hammer drilled holes with hollow drill bit and diamond cored holes with Hilti roughening tool:  $\psi_{sus} = 0.88$

### Embedment depth <sup>a)</sup> and base material thickness

Anchor size	ETA-16/0143, issue 2019-05-14								Hilti technical data			
	M8	M10	M12	M16	M20	M24	M27	M30	M33	M36	M39	
<b>HAS-U</b>												
Eff. anchorage depth [mm]	80	90	110	125	170	210	240	270	300	330	360	
Base material thickness [mm]	110	120	140	161	214	266	300	340	374	410	444	
<b>HIS-N</b>												
Eff. anchorage depth [mm]	90	110	125	170	205	-	-	-	-	-	-	
Base material thickness [mm]	120	150	170	230	270	-	-	-	-	-	-	

a) The allowed range of embedment depth is shown in the setting

### For hammer drilled holes, hollow drill bit<sup>1)</sup> and diamond cored with roughening tool<sup>2)</sup>:

#### Characteristic resistance

Anchor size	ETA-16/0143, issue 2019-05-14								Hilti technical data			
	M8	M10	M12	M16	M20	M24	M27	M30	M33	M36	M39	
<b>Non-cracked concrete</b>												
Tension $N_{Rk}$ [kN]	HAS-U 5.8	18,0	29,0	42,0	76,9	122	168	205	244	286	330	376
	HAS-U 8.8, AM	29,0	46,0	63,5	76,9	122	168	205	244	286	330	376
	HAS-U A4	26,0	41,0	59,0	76,9	122	168	205	244	286	330	376
	HAS-U HCR	29,0	46,0	63,5	76,9	122	168	205	244	286	330	376
	HIS-N 8.8	25,0	46,0	67,0	121,9	116	-	-	-	-	-	-
Shear $V_{Rk}$ [kN]	HAS-U 5.8	9,0	15,0	21,0	39,0	61,0	88,0	115	140	174	204	244
	HAS-U 8.8, AM	15,0	23,0	34,0	63,0	98,0	141	184	224	278	327	390
	HAS-U A4	13,0	20,0	30,0	55,0	86,0	124	115	140	174	204	244
	HAS-U HCR	15,0	23,0	34,0	63,0	98,0	124	161	196	174	204	244
	HIS-N 8.8	13,0	23,0	34,0	63,0	58,0	-	-	-	-	-	-
<b>Cracked concrete</b>												
Tension $N_{Rk}$ [kN]	HAS-U 5.8	15,1	22,6	39,4	53,8	85,3	117	143	171	-	-	-
	HAS-U 8.8, AM	15,1	22,6	39,4	53,8	85,3	117	143	171	-	-	-
	HAS-U A4	15,1	22,6	39,4	53,8	85,3	117	143	171	-	-	-
	HAS-U HCR	15,1	22,6	39,4	53,8	85,3	117	143	171	-	-	-
	HIS-N 8.8	25,0	44,4	53,8	85,3	113	-	-	-	-	-	-
Shear $V_{Rk}$ [kN]	HAS-U 5.8	9,0	15,0	21,0	39,0	61,0	88,0	115	140	-	-	-
	HAS-U 8.8, AM	15,0	23,0	34,0	63,0	98,0	141	184	224	-	-	-
	HAS-U A4	13,0	20,0	30,0	55,0	86,0	124	115	140	-	-	-
	HAS-U HCR	15,0	23,0	34,0	63,0	98,0	124	161	196	-	-	-
	HIS-N 8.8	13,0	23,0	34,0	63,0	58,0	-	-	-	-	-	-

1) Hilti hollow drill bit available for element size M12-M30.

2) Roughening tools are available for element size M16-M30.

### Design resistance

Anchor size		ETA-16/0143, issue 2019-05-14								Hilti tech. data		
		M8	M10	M12	M16	M20	M24	M27	M30	M33	M36	M39
<b>Non-cracked concrete</b>												
Tension $N_{Rd}$	HAS-U 5.8	12,0	19,3	28,0	45,8	72,7	99,8	122	146	142	164	187
	HAS-U 8.8, AM 8.8	19,3	28,0	37,8	45,8	72,7	99,8	122	146	142	164	187
	HAS-U A4 [kN]	13,9	21,9	31,6	45,8	72,7	99,8	80,4	98,3	121	143	171
	HAS-U HCR	19,3	28,0	37,8	45,8	72,7	99,8	122	146	142	164	187
	HIS-N 8.8	16,7	30,7	44,7	72,7	77,3	-	-	-	-	-	-
Shear $V_{Rd}$	HAS-U 5.8	7,2	12,0	16,8	31,2	48,8	70,4	92,0	112	139	163	195
	HAS-U 8.8, AM 8.8	12,0	18,4	27,2	50,4	78,4	113	147	179	222	262	312
	HAS-U A4 [kN]	8,3	12,8	19,2	35,3	55,1	79,5	48,3	58,8	73,1	85,7	103
	HAS-U HCR	12,0	18,4	27,2	50,4	78,4	70,9	92,0	112	87,0	102	122
	HIS-N 8.8	10,4	18,4	27,2	50,4	46,4	-	-	-	-	-	-
<b>Cracked concrete</b>												
Tension $N_{Rd}$	HAS-U 5.8	10,1	15,1	26,3	32,1	50,9	69,9	85,4	102	-	-	-
	HAS-U 8.8, AM 8.8	10,1	15,1	26,3	32,1	50,9	69,9	85,4	102	-	-	-
	HAS-U A4 [kN]	10,1	15,1	26,3	32,1	50,9	69,9	80,4	98,3	-	-	-
	HAS-U HCR	10,1	15,1	26,3	32,1	50,9	69,9	85,4	102	-	-	-
	HIS-N 8.8	16,7	26,5	32,1	50,9	67,4	-	-	-	-	-	-
Shear $V_{Rd}$	HAS-U 5.8	7,2	12,0	16,8	31,2	48,8	70,4	92,0	112	-	-	-
	HAS-U 8.8, AM 8.8	12,0	18,4	27,2	50,4	78,4	113	147	179	-	-	-
	HAS-U A4 [kN]	8,3	12,8	19,2	35,3	55,1	79,5	48,3	58,8	-	-	-
	HAS-U HCR	12,0	18,4	27,2	50,4	78,4	70,9	92,0	112	-	-	-
	HIS-N 8.8	10,4	18,4	27,2	50,4	46,4	-	-	-	-	-	-

1) Hilti hollow drill bit available for element size M12-M30.

2) Roughening tools are available for element size M16-M30.

**Recommended loads a)**

Anchor size		ETA-16/0143, issue 2019-05-14								Hilti technical data		
		M8	M10	M12	M16	M20	M24	M27	M30	M33	M36	M39
<b>Non-cracked concrete</b>												
Tension $N_{Rec}$	HAS-U 5.8	8,6	13,8	20,0	32,7	51,9	71,3	87,1	104	101	117	133
	HAS-U 8.8, AM	13,8	20,0	27,0	32,7	51,9	71,3	87,1	104	101	117	133
	HAS-U A4	9,9	15,7	22,5	32,7	51,9	71,3	57,4	70,2	86,7	102	122
	HAS-U HCR	13,8	20,0	27,0	32,7	51,9	71,3	87,1	104	101	117	133
	HIS-N 8.8	11,9	21,9	31,9	51,9	55,2	-	-	-	-	-	-
Shear $V_{Rec}$	HAS-U 5.8	5,1	8,6	12,0	22,3	34,9	50,3	65,7	80,0	99,4	117	139
	HAS-U 8.8, AM	8,6	13,1	19,4	36,0	56,0	80,6	105	128	159	187	223
	HAS-U A4	6,0	9,2	13,7	25,2	39,4	56,8	34,5	42,0	52,2	61,2	73,2
	HAS-U HCR	8,6	13,1	19,4	36,0	56,0	50,6	65,7	80,0	62,1	72,9	87,1
	HIS-N 8.8	7,4	13,1	19,4	36,0	33,1	-	-	-	-	-	-
<b>Cracked concrete</b>												
Tension $N_{Rec}$	HAS-U 5.8	7,2	10,8	18,8	22,9	36,3	49,9	61,0	72,7	-	-	-
	HAS-U 8.8, AM	7,2	10,8	18,8	22,9	36,3	49,9	61,0	72,7	-	-	-
	HAS-U A4	7,2	10,8	18,8	22,9	36,3	49,9	57,4	70,2	-	-	-
	HAS-U HCR	7,2	10,8	18,8	22,9	36,3	49,9	61,0	72,7	-	-	-
	HIS-N 8.8	11,9	18,9	22,9	36,3	48,1	-	-	-	-	-	-
Shear $V_{Rec}$	HAS-U 5.8	5,1	8,6	12,0	22,3	34,9	50,3	65,7	80,0	-	-	-
	HAS-U 8.8, AM	8,6	13,1	19,4	36,0	56,0	80,6	105	128	-	-	-
	HAS-U A4	6,0	9,2	13,7	25,2	39,4	56,8	34,5	42,0	-	-	-
	HAS-U HCR	8,6	13,1	19,4	36,0	56,0	50,6	65,7	80,0	-	-	-
	HIS-N 8.8	7,4	13,1	19,4	36,0	33,1	-	-	-	-	-	-

a) With overall partial safety factor for action  $\gamma=1,4$ . The partial safety factors for action depend on the type of loading and shall be taken from national regulations.

**For diamond drilling:**
**Characteristic resistance**

Anchor size		M8	M10	M12	M16	M20	M24	M27	M30
<b>Non-cracked concrete</b>									
Tension $N_{Rk}$	HAS-U 5.8	18,0	29,0	42,0	76,9	122	167	205	244
	HIS-N 8.8	25,0	46,0	67,0	122	116	-	-	-
Shear $V_{Rk}$	HAS-U 5.8	9,0	15,0	21,0	39,0	61,0	88,0	115	140
	HIS-N 8.8	13,0	23,0	34,0	63,0	58,0	-	-	-

**Design resistance**

Anchor size		M8	M10	M12	M16	M20	M24	M27	M30
<b>Non-cracked concrete</b>									
Tension $N_{Rd}$	HAS-U 5.8	12,0	19,3	28,0	32,7	51,9	71,3	87,1	104
	HIS-N 8.8	16,7	24,4	32,7	51,9	68,8	-	-	-
Shear $V_{Rd}$	HAS-U 5.8	7,2	12,0	16,8	31,2	48,8	70,4	92,0	112
	HIS-N 8.8	10,4	18,4	27,2	50,4	46,4	-	-	-

### Recommended loads <sup>b)</sup>

Anchor size		M8	M10	M12	M16	M20	M24	M27	M30
<b>Non-cracked concrete</b>									
Tensile $N_{Rec}$	HAS-U 5.8	8,6	13,8	20,0	23,4	37,1	50,9	62,2	74,2
	HIS-N 8.8	11,9	17,5	23,4	37,1	49,1	-	-	-
Shear $V_{Rec}$	HAS-U 5.8	5,1	8,6	12,0	22,3	34,9	50,3	65,7	80,0
	HIS-N 8.8	7,4	13,1	19,4	36,0	33,1	-	-	-

a) With overall partial safety factor for action  $\gamma=1,4$ . The partial safety factors for action depend on the type of loading and shall be taken from national regulations.

### Seismic resistance

#### All data in this section applies to:

- Correct setting (See setting instruction)
- No edge distance and spacing influence
- Steel failure
- Anchor HAS-U strength class 8.8, anchor AM 8.8
- Base material thickness, as specified in the table
- One typical embedment depth as specified in the table
- Concrete C 20/25,  $f_{ck,cube} = 25 \text{ N/mm}^2$
- Temperature range I  
(min. base material temperature  $-40^\circ\text{C}$ , max. long/short term base material temperature:  $+24^\circ\text{C}/40^\circ\text{C}$ )
- $\alpha_{gap}=1,0$  (using Hilti seismic filling set)

#### Embedment depth and base material thickness for seismic C2 <sup>a)</sup> and C1

Anchor size		M8	M10	M12	M16	M20	M24	M27	M30
<b>HAS-U</b>									
Eff. Anchorage depth	[mm]	80	90	110	125	170	210	240	270
Base material thickness	[mm]	110	120	140	161	214	266	300	340
<b>HIS-N</b>									
Eff. Anchorage depth	[mm]	90	110	125	170	205	-	-	-
Base material thickness	[mm]	120	146	169	226	269	-	-	-

a) C2 seismic approval only available for HAS-U rods.

#### For hammer drilled holes, hollow drill bit and diamond cored with roughening tool:

#### Characteristic resistance in case of seismic performance category C2

Anchor size		M8	M10	M12	M16	M20	M24	M27	M30
Tensile $N_{Rk}$	HAS-U 8.8, AM 8.8 [kN]	-	-	-	37,1	57,7	80,8	102	132
Shear $V_{Rk}$	HAS-U 8.8, AM 8.8 w/ filling set	-	-	-	46,0	77,0	103	-	-
	HAS-U 8.8, AM 8.8 w/o filling set	-	-	-	40,0	71,0	90,0	121	135

#### Design resistance in case of seismic performance category C2

Anchor size		M8	M10	M12	M16	M20	M24	M27	M30
Tensile $N_{Rd}$	HAS-U 8.8, AM 8.8 [kN]	-	-	-	24,7	38,5	53,8	67,9	88,2
Shear $V_{Rd}$	HAS-U 8.8, AM 8.8 w/ filling set	-	-	-	36,8	61,6	82,4	-	-
	HAS-U 8.8, AM 8.8 w/o filling set	-	-	-	32,0	56,8	72,0	96,8	108

For hammer drilled holes and hammer drilled holes with Hilti hollow drill bit:

**Characteristic resistance in case of seismic performance category C1**

Anchor size		M8	M10	M12	M16	M20	M24	M27	M30
Tensile $N_{Rk}$	HAS-U 8.8, AM 8.8 [kN]	13,7	22,6	37,8	45,7	72,5	99,6	122	145
	HIS-N 8.8	25,0	37,8	45,7	72,5	96,1	-	-	-
Shear $V_{Rk}$	HAS-U 8.8, AM 8.8 [kN]	15,0	23,0	34,0	63,0	98,0	141	184	224
	HIS-N 8.8	9,0	16,0	24,0	44,0	41,0	-	-	-

**Design resistance in case of seismic performance category C1**

Anchor size		M8	M10	M12	M16	M20	M24	M27	M30
Tensile $N_{Rd}$	HAS-U 8.8, AM 8.8 [kN]	9,1	15,1	25,2	30,5	48,4	66,4	81,1	96,8
	HIS-N 8.8	16,7	25,2	30,5	48,4	64,0	-	-	-
Shear $V_{Rd}$	HAS-U 8.8, AM 8.8 [kN]	12,0	18,4	27,2	50,4	78,4	113	147	179
	HIS-N 8.8	7,2	12,8	19,2	35,2	32,8	-	-	-

**Materials**

**Mechanical properties for HAS-U**

Anchor size		ETA-16/0143, issue 2019-05-14								Hilti Technical data		
		M8	M10	M12	M16	M20	M24	M27	M30	M33	M36	M39
Nominal tensile strength $f_{uk}$	HAS-U 5.8(F)	500	500	500	500	500	500	500	500	500	500	500
	HAS-U 8.8(F)	800	800	800	800	800	800	800	800	800	800	800
	AM 8.8(HDG) [N/mm <sup>2</sup> ]	800	800	800	800	800	800	800	800	800	800	800
	HAS-U A4	700	700	700	700	700	700	500	500	500	500	500
	HAS-U HCR	800	800	800	800	800	700	700	700	500	500	500
Yield strength $f_{yk}$	HAS-U 5.8(F)	400	400	400	400	400	400	400	400	400	400	400
	HAS-U 8.8(F)	640	640	640	640	640	640	640	640	640	640	640
	AM 8.8(HDG) [N/mm <sup>2</sup> ]	640	640	640	640	640	640	640	640	640	640	640
	HAS-U A4	450	450	450	450	450	450	210	210	210	210	210
	HAS-U HCR	640	640	640	640	640	400	400	400	250	250	250
Stressed cross-section $A_s$	HAS-U AM 8.8 [mm <sup>2</sup> ]	36,6	58,0	84,3	157	245	353	459	561	694	817	976
Moment of resistance $W$	HAS-U AM 8.8 [mm <sup>3</sup> ]	31,2	62,3	109	277	541	935	1387	1874	2579	3294	4301

**Mechanical properties for HIS-N**

Anchor size		ETA-16/0143, issue 2019-05-14				
		M8	M10	M12	M16	M20
Nominal tensile strength $f_{uk}$	HIS-N	490	490	460	460	460
	Screw 8.8 [N/mm <sup>2</sup> ]	800	800	800	800	800
	HIS-RN	700	700	700	700	700
	Screw A4-70	700	700	700	700	700
Yield strength $f_{yk}$	HIS-N	410	410	375	375	375
	Screw 8.8 [N/mm <sup>2</sup> ]	640	640	640	640	640
	HIS-RN	350	350	350	350	350
	Screw A4-70	450	450	450	450	450
Stressed cross-section $A_s$	HIS-(R)N [mm <sup>2</sup> ]	51,5	108	169	256	238
	Screw	36,6	58	84,3	157	245
Moment of resistance $W$	HIS-(R)N [mm <sup>3</sup> ]	145	430	840	1595	1543
	Screw	31,2	62,3	109	277	541





### Material quality for HAS-U

Part	Material
<b>Zinc coated steel</b>	
Threaded rod, HAS-U 5.8 (HDG)	Strength class 5.8; Elongation at fracture A5 > 8% ductile Electroplated zinc coated $\geq 5\mu\text{m}$ ; (F) hot dip galvanized $\geq 45\mu\text{m}$
Threaded rod, HAS-U 8.8 (HDG)	Strength class 8.8; Elongation at fracture A5 > 12% ductile Electroplated zinc coated $\geq 5\mu\text{m}$ ; (F) hot dip galvanized $\geq 45\mu\text{m}$
Hilti Meter rod, AM 8.8 (HDG)	Strength class 8.8; Elongation at fracture A5 > 12% ductile Electroplated zinc coated $\geq 5\mu\text{m}$ (HDG) hot dip galvanized $\geq 45\mu\text{m}$
Washer	Electroplated zinc coated $\geq 5\mu\text{m}$ , hot dip galvanized $\geq 45\mu\text{m}$
Nut	Strength class of nut adapted to strength class of threaded rod. Electroplated zinc coated $\geq 5\mu\text{m}$ , hot dip galvanized $\geq 45\mu\text{m}$
<b>Stainless Steel</b>	
Threaded rod, HAS-U A4	Strength class 70 for $\leq M24$ and strength class 50 for $> M24$ ; Elongation at fracture A5 > 8% ductile Stainless steel 1.4401; 1.4404; 1.4578; 1.4571; 1.4439; 1.4362
Washer	Stainless steel 1.4401, 1.4404, 1.4578, 1.4571, 1.4439, 1.4362 EN 10088-1:2014
Nut	Stainless steel 1.4401, 1.4404, 1.4578, 1.4571, 1.4439, 1.4362 EN 10088-1:2014
<b>High corrosion resistant steel</b>	
Threaded rod, HAS-U HCR	Strength class 80 for $\leq M20$ and class 70 for $> M20$ , Elongation at fracture A5 > 8% ductile High corrosion resistance steel 1.4529; 1.4565;
Washer	High corrosion resistant steel 1.4529, 1.4565 EN 10088-1:2014
Nut	High corrosion resistant steel 1.4529, 1.4565 EN 10088-1:2014

### Material quality for HIS-N

Part	Material	
HIS-N	Internal threaded sleeve	C-steel 1.0718; Steel galvanized $\geq 5\mu\text{m}$
	Screw 8.8	Strength class 8.8, A5 > 8 % Ductile; Steel galvanized $\geq 5\mu\text{m}$
HIS-RN	Internal threaded sleeve	Stainless steel 1.4401, 1.4571
	Screw 70	Strength class 70, A5 > 8 % Ductile Stainless steel 1.4401; 1.4404, 1.4578; 1.4571; 1.4439; 1.4362

### Setting information

#### Installation temperature

-5°C to +40°C

#### Service temperature range

Hilti HIT-RE 500 V3 injection mortar may be applied in the temperature ranges given below. An elevated base material temperature may lead to a reduction of the design bond resistance.

Temperature range	Base material temperature	Max. long term base material temperature	Max. short term base material temperature
Temperature range I	-40 °C to +40 °C	+24 °C	+40 °C
Temperature range II	-40 °C to +70 °C	+43 °C	+70 °C



### Max short term base material temperature

Short-term elevated base material temperatures are those that occur over brief intervals, e.g. as a result of diurnal cycling.

### Max long term base material temperature

Long-term elevated base material temperatures are roughly constant over significant periods of time.

### Working time and curing time

Temperature of the base material T	Working time t <sub>work</sub>	Minimum curing time t <sub>cure</sub> <sup>1)</sup>
-5 °C to -1 °C	2 h	168 h
0 °C to 4 °C	2 h	48 h
5 °C to 9 °C	2 h	24 h
10 °C to 14 °C	1,5 h	16 h
15 °C to 19 °C	1 h	12 h
20 °C to 24 °C	30 min	7 h
25 °C to 29 °C	20 min	6 h
30 °C to 34 °C	15 min	5 h
35 °C to 39 °C	12 min	4,5 h
40 °C	10 min	4 h

1) The curing time data are valid for dry base material only. In wet base material, the curing times must be doubled.

### Setting details for HAS-U

Anchor size		ETA-16/0143, issue 2019-05-14								Hilti Technical data		
		M8	M10	M12	M16	M20	M24	M27	M30	M33	M36	M39
Nominal diameter of drill bit	d <sub>0</sub> [mm]	10	12	14	18	22	28	30	35	37	40	42
Effective anchorage and drill hole depth range <sup>a)</sup>	h <sub>ef,min</sub> [mm]	60	60	70	80	90	96	108	120	132	144	156
	h <sub>ef,max</sub> [mm]	160	200	240	320	400	480	540	600	660	720	780
Minimum base material thickness	h <sub>min</sub> [mm]	h <sub>ef</sub> + 30 mm ≥ 100 mm				h <sub>ef</sub> + 2 d <sub>0</sub>						
Max. torque moment	T <sub>max</sub> [Nm]	10	20	40	80	150	200	270	300	330	360	390
Minimum spacing	s <sub>min</sub> [mm]	40	50	60	75	90	115	120	140	165	180	195
Min. edge distance	c <sub>min</sub> [mm]	40	45	45	50	55	60	75	80	165	180	195
Critical spacing for splitting failure	s <sub>cr,sp</sub> [mm]	2 c <sub>cr,sp</sub>										
Critical edge distance for splitting failure <sup>b)</sup>	c <sub>cr,sp</sub> [mm]	1,0 · h <sub>ef</sub> for h / h <sub>ef</sub> ≥ 2,0										
		4,6 h <sub>ef</sub> - 1,8 h for 2,0 > h / h <sub>ef</sub> > 1,3										
		2,26 h <sub>ef</sub> for h / h <sub>ef</sub> ≤ 1,3										
Critical spacing for concrete cone failure	s <sub>cr,N</sub> [mm]	2 c <sub>cr,N</sub>										
Critical edge distance for concrete cone failure <sup>c)</sup>	c <sub>cr,N</sub> [mm]	1,5 h <sub>ef</sub>										

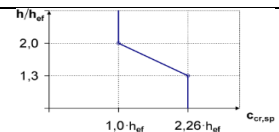

### HAS-U-...



#### Marking:

Steel grade number and length identification letter: e.g. 8 L

### Setting details for HIS-N

Anchor size		M8	M10	M12	M16	M20
Nominal diameter of drill	$d_0$ [mm]	14	18	22	28	32
Diameter of element	$d$ [mm]	12,5	16,5	20,5	25,4	27,6
Effective anchorage and drill hole depth	$h_{ef}$ [mm]	90	110	125	170	205
Minimum base material thickness	$h_{min}$ [mm]	120	150	170	230	270
Diameter of clearance hole in the fixture	$d_f$ [mm]	9	12	14	18	22
Thread engagement length; min - max	$h_s$ [mm]	8-20	10-25	12-30	16-40	20-50
Minimum spacing	$s_{min}$ [mm]	60	70	90	115	130
Minimum edge distance	$c_{min}$ [mm]	40	45	55	65	90
Critical spacing for splitting failure	$s_{cr,sp}$ [mm]	$2 c_{cr,sp}$				
Critical edge distance for splitting failure <sup>b)</sup>	$c_{cr,sp}$ [mm]	$1,0 \cdot h_{ef}$ for $h / h_{ef} \geq 2,0$				
		$4,6 h_{ef} - 1,8 h$ for $2,0 > h / h_{ef} > 1,3$				
		$2,26 h_{ef}$ for $h / h_{ef} \leq 1,3$				
Critical spacing for concrete cone failure	$s_{cr,N}$ [mm]	$2 c_{cr,N}$				
Critical edge distance for concrete cone failure <sup>c)</sup>	$c_{cr,N}$ [mm]	$1,5 h_{ef}$				
Max. torque moment <sup>a)</sup>	$T_{max}$ [Nm]	10	20	40	80	150

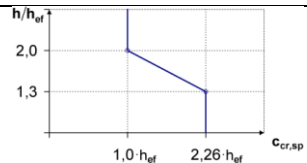

For spacing (edge distance) smaller than critical spacing (critical edge distance) the design loads have to be reduced.

a)  $h_{ef,min} \leq h_{ef} \leq h_{ef,max}$  ( $h_{ef}$ : embedment depth)

b)  $h$ : base material thickness ( $h \geq h_{min}$ )

c) The critical edge distance for concrete cone failure depends on the embedment depth  $h_{ef}$  and the design bond resistance. The simplified formula given in this table is on the save side.

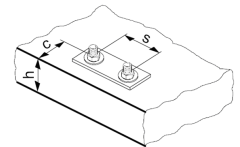

### Internally threaded sleeve HIS-(R)N...

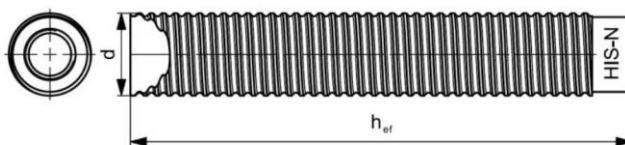

#### Marking:

Identifying mark - HILTI and embossing "HIS-N" (for zinc coated steel)  
embossing "HIS-RN" (for stainless steel)

### Installation equipment

Anchor size		M8	M10	M12	M16	M20	M24	M27	M30	M36	M39	
Rotary hammer	HAS-U	TE 2 – TE 16				TE 40 – TE 80				Not available from Hilti		
	HIS-N	TE 2 – TE 16	TE 40 – TE 80			-						
Other tools	compressed air gun, set of cleaning brushes, dispenser											
	roughening tools TE-YRT										-	
Additional Hilti recommended tools		DD EC-1, DD 100 ... DD 160 <sup>a)</sup>									-	

a) For anchors in diamond drilled holes load values for combined pull-out and concrete cone resistance have to be reduced

Minimum roughening time  $t_{\text{roughen}}$  ( $t_{\text{roughen}} [\text{sec}] = h_{\text{ef}} [\text{mm}] / 10$ )

$h_{\text{ef}} [\text{mm}]$	$t_{\text{roughen}} [\text{sec}]$
0 to 100	10
101 to 200	20
201 to 300	30
301 to 400	40
401 to 500	50
501 to 600	60

Parameters of cleaning and setting tools

HAS-U	HIS-N	Drill bit diameters $d_0$ [mm]				Installation	
		Hammer drill (HD)	Hollow Drill Bit (HDB)	Diamond coring		Brush HIT-RB	Piston plug HIT-SZ
				Diamond coring (DD)	With roughening tool (RT)		
<b>M8</b>	-	10	-	10	-	10	-
<b>M10</b>	-	12	-	12	-	12	12
<b>M12</b>	<b>M8</b>	14	14	14	-	14	14
<b>M16</b>	<b>M10</b>	18	18	18	18	18	18
<b>M20</b>	<b>M12</b>	22	22	22	22	22	22
<b>M24</b>	<b>M16</b>	28	28	28	28	28	28
<b>M27</b>	-	30	-	30	30	30	30
-	<b>M20</b>	32	32	32	32	32	32
<b>M30</b>	-	35	35	35	35	35	35
<b>M33</b>	-	37	-	-	-	37	37
<b>M36</b>	-	40	-	-	-	40	40
<b>M39</b>	-	42	-	-	-	42	42

Associated components for the use of Hilti Roughening tool TE-YRT

Diamond coring		Roughening tool TE-YRT	Wear gauge RTG...
$d_0$ [mm]		$d_0$ [mm]	size
Nominal	measured		
18	17,9 to 18,2	18	18
20	19,9 to 20,2	20	20
22	21,9 to 22,2	22	22
25	24,9 to 25,2	25	25
28	27,9 to 28,2	28	28
30	29,9 to 30,2	30	30
32	31,9 to 32,2	32	32
35	34,9 to 35,2	35	35

## Setting instructions

\*For detailed information on installation see instruction for use given with the package of the product.



### Safety regulations.

Review the Material Safety Data Sheet (MSDS) before use for proper and safe handling! Wear well-fitting protective goggles and protective gloves when working with Hilti HIT-RE 500 V3.

### Drilling

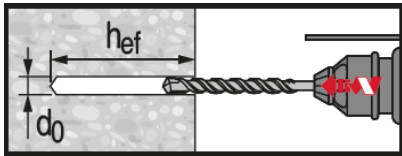

#### Hammer drilled hole

For dry and wet concrete and installation in flooded holes (no sea water).

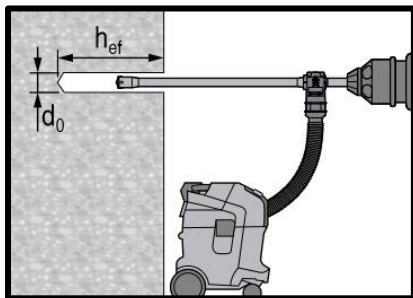

#### Hammer drilled hole with Hollow Drilled Bit (HDB)

No cleaning required.  
For dry and wet concrete, only.

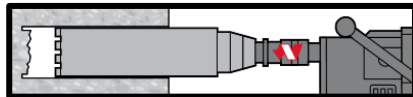

#### Diamond Coring

For dry and wet concrete, only.

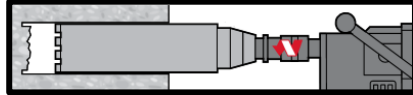

#### Diamond Coring + Roughening Tool

For dry and wet concrete only.  
Before roughening, the borehole needs to be dry.

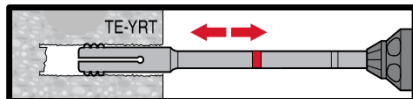

### Cleaning ( Inadequate hole cleaning=poor load values.)

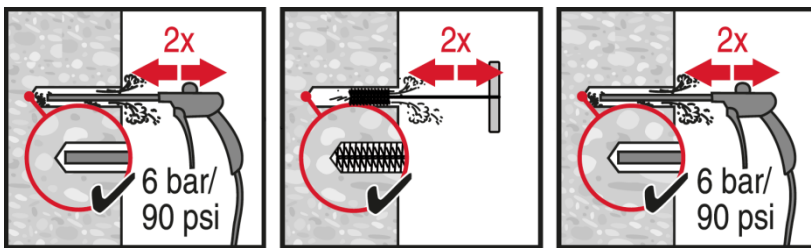

#### Hammer Drilling:

##### Compressed air cleaning (CAC)

For all drill hole diameters  $d_0$  and all drill hole depths  $h_0$ .

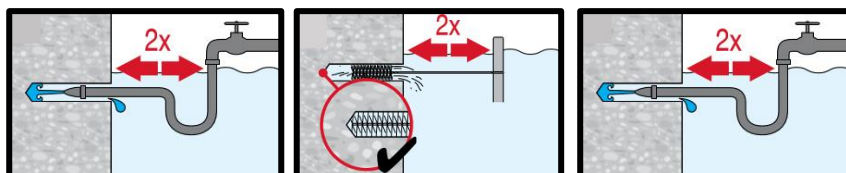

#### Hammer drilling:

##### Cleaning for under water:

For all bore hole diameters  $d_0$  and all bore hole depth  $h_0$ .

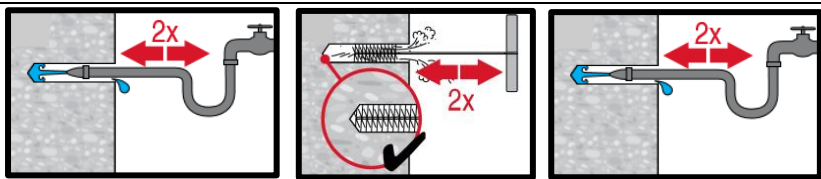

**Hammer drilled flooded holes and diamond cored holes:**

**Compressed air cleaning (CAC)** for all drill hole diameters  $d_0$  and drill hole depths  $h_0$ .

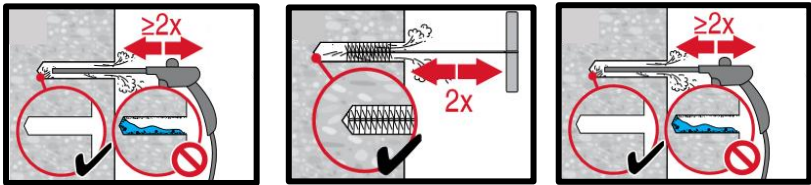

**Diamond cored holes with Hilti roughening tool:**

**Compressed air cleaning (CAC)** for all drill hole diameters  $d_0$  and drill hole depths  $h_0$ .

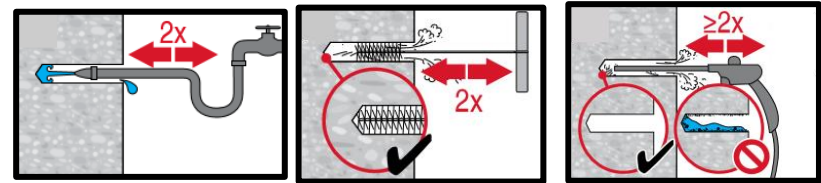

**Injection preparation**

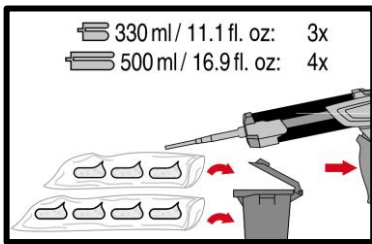
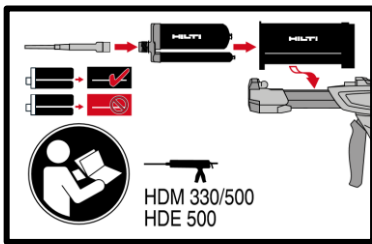

**Injection system preparation.**

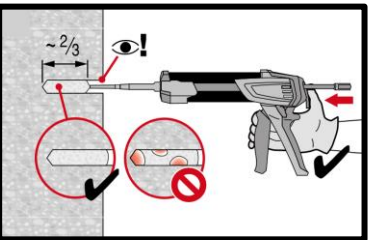
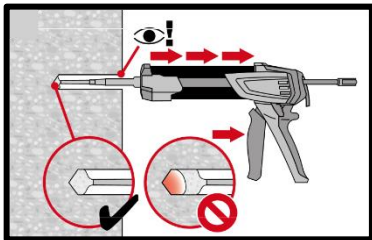

**Injection method for drill hole depth**  
 $h_{ef} \leq 250 \text{ mm}$ .

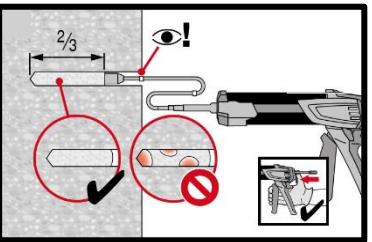
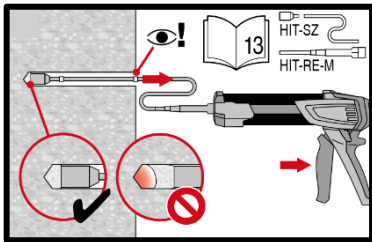

**Injection method for drill hole depth**  
 $h_{ef} > 250 \text{ mm}$ .

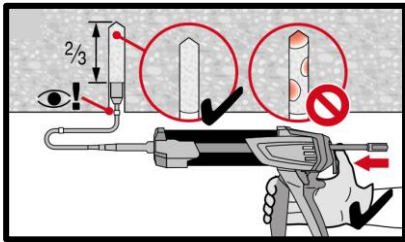
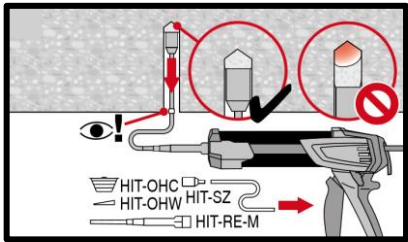

**Injection method for overhead application.**

## Setting the element

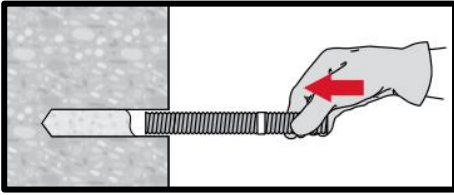

**Setting element**, observe working time " $t_{work}$ ",

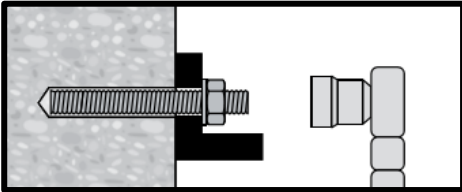

**Loading the anchor** after required curing time  $t_{cure}$  the anchor can be loaded. The applied installation torque shall not exceed  $T_{max}$ .

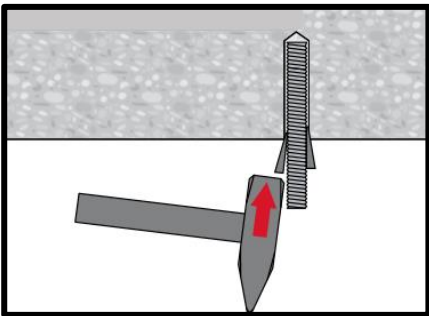

**Setting element** for overhead applications, observe working time " $t_{work}$ "

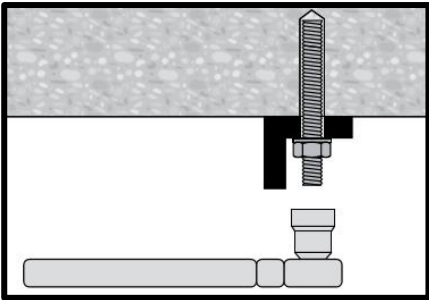

**Loading the anchor** after required curing time  $t_{cure}$  the anchor can be loaded. The applied installation torque shall not exceed  $T_{max}$ .







# HIT-RE 500 V3 injection mortar

Anchor design (EN 1992-4) / Rebar elements / Concrete

## Injection mortar system



Hilti  
HIT-RE 500 V3  
500 ml foil pack  
(also available as  
330 ml and 1400  
ml foil pack)



Rebar B500 B  
( $\phi 8$  -  $\phi 40$ )

## Benefits

- **SafeSet** technology: Simplified method of borehole preparation using either Hilti hollow drill bit for hammer drilling or Roughening tool for diamond cored applications
- Suitable for non-cracked and cracked concrete C 20/25 to C 50/60
- ETA approval for seismic performance category C1
- Hilti Technical Data for seismic performance category C2
- High loading capacity
- Suitable for dry and water saturated concrete
- Hilti Technical Data for under water application
- Fastest curing epoxy mortar to speed up construction process
- Long working time to allow installation of big diameters and/or deep embedment depths even at higher temperature
- Cures down to -5°C

## Base material



Concrete (non-cracked)

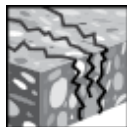

Concrete (cracked)



Dry concrete



Wet concrete

## Load conditions



Static/  
quasi-static



Seismic,  
ETA-C1

Hilti Technical Data-C2

## Installation conditions

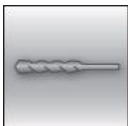

Hammer  
drilling



Diamond  
coring

**SAFE-SET**

Hilti **SafeSet**  
technology

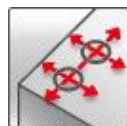

Small edge  
distance and  
spacing



European  
Technical  
Assessment



CE  
conformity



PROFIS  
Rebar design  
Software

## Approvals / certificates

Description	Authority / Laboratory	No. / date of issue
European technical assessment <sup>a)</sup>	CSTB, Marne la Vallée	ETA-16/0143 / 2019-05-14

a) All data given in this section according to ETA-16/0143 issue 2019-05-14.

## Static and quasi-static loading (for a single anchor)

### All data in this section applies to

- Design according to TR029
- Correct setting (See setting instruction)
- No edge distance and spacing influence
- Steel failure
- Base material thickness, as specified in the table
- One typical embedment depth, as specified in the table
- Rebar B500B
- Concrete C 20/25,  $f_{ck,cube} = 25 \text{ N/mm}^2$
- Temperature range I (min. base material temp.  $-40^\circ\text{C}$ , max. long term/short term base material temp.:  $+24^\circ\text{C}/40^\circ\text{C}$ )
- Short term loading. For long term loading please apply  $\psi_{sus}$ .
  - Hammer drilled holes, hammer drilled holes with hollow drill bit and diamond cored holes with Hilti roughening tool:  $\psi_{sus} = 0.88$

### Embedment depth and base material thickness for static and quasi-static loading data

Anchor- size	ETA-16/0143, issue 2019-05-14										Hilti technical data	
	$\phi 8$	$\phi 10$	$\phi 12$	$\phi 14$	$\phi 16$	$\phi 20$	$\phi 25$	$\phi 28$	$\phi 30$	$\phi 32$	$\phi 36$	$\phi 40$
Typ. embedment depth [mm]	80	90	110	125	125	170	210	270	270	300	330	360
Base material thickness [mm]	110	120	142	161	165	220	274	340	344	380	420	470

### For hammer drilled holes, hollow drill bit<sup>1)</sup> and diamond cored with roughening tool<sup>2)</sup>:

- 1) Hilti hollow drill bit available for element size  $\phi 10$ - $\phi 28$ .
- 2) Roughening tools are available for element size  $\phi 14$ - $\phi 28$ .

### Characteristic resistance

Anchor- size	ETA-16/0143, issue 2019-05-14										Hilti technical data	
	$\phi 8$	$\phi 10$	$\phi 12$	$\phi 14$	$\phi 16$	$\phi 20$	$\phi 25$	$\phi 28$	$\phi 30$	$\phi 32$	$\phi 36$	$\phi 40$
<b>Non-cracked concrete</b>												
Tensile $N_{Rk}$ B500B	[kN]											
Shear $V_{Rk}$ B500B	20,1	42,4	62,0	76,9	76,9	122	167	244	244	286	330	376
Shear $V_{Rk}$ B500B	14,0	22,0	31,0	42,0	55,0	86,0	135	169	194	221	280	346
<b>Cracked concrete</b>												
Tensile $N_{Rk}$ B500B	[kN]											
Shear $V_{Rk}$ B500B	-	24,0	39,4	52,2	53,8	85,3	117	171	171	200	-	-
Shear $V_{Rk}$ B500B	-	22,0	31,0	42,0	55,0	86,0	135	169	194	221	-	-

- 1) Hilti hollow drill bit available for element size  $\phi 10$ - $\phi 28$ .
- 2) Roughening tools are available for element size  $\phi 14$ - $\phi 28$ .

### Design resistance

Anchor- size	ETA-16/0143, issue 2019-05-14										Hilti technical data	
	$\phi 8$	$\phi 10$	$\phi 12$	$\phi 14$	$\phi 16$	$\phi 20$	$\phi 25$	$\phi 28$	$\phi 30$	$\phi 32$	$\phi 36$	$\phi 40$
<b>Non-cracked concrete</b>												
Tensile $N_{Rd}$ B500B	[kN]											
Shear $V_{Rd}$ B500B	13,4	28,0	37,8	45,8	45,8	72,7	99,8	146	146	170	164	187
Shear $V_{Rd}$ B500B	9,3	14,7	20,7	28,0	36,7	57,3	90,0	113	129	147	187	231
<b>Cracked concrete</b>												
Tensile $N_{Rd}$ B500B	[kN]											
Shear $V_{Rd}$ B500B	-	16,0	26,3	32,1	32,1	50,9	69,9	102	102	119	-	-
Shear $V_{Rd}$ B500B	-	14,7	20,7	28,0	36,7	57,3	90,0	113	129	147	-	-

- 1) Hilti hollow drill bit available for element size  $\phi 10$ - $\phi 28$ .
- 2) Roughening tools are available for element size  $\phi 14$ - $\phi 28$ .

### Recommended loads<sup>3)</sup>

Anchor- size		ETA-16/0143, issue 2019-05-14										Hilti technical data		
		φ8	φ10	φ12	φ14	φ16	φ20	φ25	φ28	φ30	φ32	φ36	φ40	
<b>Non-cracked concrete</b>														
Tensile N <sub>Rec</sub>	B500B	[kN]	9,6	20,0	27,0	32,7	32,7	51,9	71,3	104	104	122	117	133
Shear V <sub>Rec</sub>	B500B		6,7	10,5	14,8	20,0	26,2	41,0	64,3	80,5	92,4	105	133	165
<b>Cracked concrete</b>														
Tensile N <sub>Rec</sub>	B500B	[kN]	-	11,4	18,8	22,9	22,9	36,3	49,9	72,7	72,7	85,2	-	-
Shear V <sub>Rec</sub>	B500B		-	10,5	14,8	20,0	26,2	41,0	64,3	80,5	92,4	105	-	-

1) Hilti hollow drill bit available for element size φ10-φ28.

2) Roughening tools are available for element size φ14-φ28.

3) With overall partial safety factor for action  $\gamma=1,4$ . The partial safety factors for action depend on the type of loading and shall be taken from national regulations.

### For diamond cored holes:

#### Characteristic resistance

Anchor- size		ETA-16/0143, issue 2019-05-14										
		φ8	φ10	φ12	φ14	φ16	φ20	φ25	φ28	φ30	φ32	
Tensile N <sub>Rk</sub>	B500B	[kN]	18,1	25,4	37,3	49,5	56,5	96,1	148	226	242	286
Shear V <sub>Rk</sub>	B500B		14,0	22,0	31,0	42,0	55,0	86,0	135	169	194	221

#### Design resistance

Anchor- size		ETA-16/0143, issue 2019-05-14										
		φ8	φ10	φ12	φ14	φ16	φ20	φ25	φ28	φ30	φ32	
Tensile N <sub>Rd</sub>	B500B	[kN]	10,1	14,1	20,7	27,5	26,9	45,8	70,7	104	104	122
Shear V <sub>Rd</sub>	B500B		9,3	14,7	20,7	28,0	36,7	57,3	90,0	113	129	147

### Recommended loads<sup>a)</sup>

Anchor- size		ETA-16/0143, issue 2019-05-14										
		φ8	φ10	φ12	φ14	φ16	φ20	φ25	φ28	φ30	φ32	
Tensile N <sub>Rec</sub>	B500B	[kN]	7,2	10,1	14,8	19,6	19,2	32,7	50,5	74,2	74,2	86,9
Shear V <sub>Rec</sub>	B500B		6,7	10,5	14,8	20,0	26,2	41,0	64,3	80,5	92,4	105

a) With overall partial safety factor for action  $\gamma=1,4$ . The partial safety factors for action depend on the type of loading and shall be taken from national regulations.

## Seismic loading (for a single anchor)

### All data in this section applies to:

- Design according to TR 045
- Correct setting (See setting)
- No edge distance and spacing influence
- Steel failure
- Minimum base material thickness
- Concrete C 20/25,  $f_{ck,cube} = 25 \text{ N/mm}^2$
- Rebar B450C
- Temperature range I  
(min. base material temperature  $-40^\circ\text{C}$ , max. long term/short term base material temperature:  $+24^\circ\text{C}/40^\circ\text{C}$ )
- Installation temperature range  $-5^\circ\text{C}$  to  $+40^\circ\text{C}$
- $\alpha_{gap} = 1,0$

For hammer drilled holes, hollow drill bit<sup>2)</sup> and diamond cored with roughening tool<sup>3)</sup>:

### Embedment depth and base material thickness in case of seismic performance category C1

Anchor- size	φ8	φ10	φ12	φ14	φ16	φ20	φ25	φ28	φ30	φ32	φ36	φ40
Typical embedment depth [mm]	-	90	110	125	125	170	210	270	270	300	-	-
Base material thickness [mm]	-	120	142	161	165	220	274	340	344	380	-	-

### Characteristic resistance in case of seismic performance category C1

Anchor- size	φ8	φ10	φ12	φ14	φ16	φ20	φ25	φ28	φ30	φ32	φ36	φ40
Tensile $N_{Rk, se}$ B500B [kN]	-	23,2	36,1	45,7	45,7	72,5	99,6	145	145	170	-	-
Shear $V_{Rk, se}$ B500B [kN]	-	15,0	22,0	29,0	39,0	60,0	95,0	118	136	155	-	-

- 1) Hilti hollow drill bit available for element size  $\phi 10$ - $\phi 28$ .
- 2) Roughening tools are available for element size  $\phi 14$ - $\phi 28$ .

### Design resistance in case of seismic performance category C1

Anchor- size	φ8	φ10	φ12	φ14	φ16	φ20	φ25	φ28	φ30	φ32	φ36	φ40
Tensile $N_{Rd, se}$ B500B [kN]	-	15,5	24,1	30,5	30,5	48,4	66,4	96,8	96,8	113	-	-
Shear $V_{Rd, se}$ B500B [kN]	-	10,0	14,7	19,3	26,0	40,0	63,3	78,7	90,7	103	-	-

- 1) Hilti hollow drill bit available for element size  $\phi 10$ - $\phi 28$ .
- 2) Roughening tools are available for element size  $\phi 14$ - $\phi 28$ .

## Materials

### Mechanical properties

Anchor size	φ8	φ10	φ12	φ14	φ16	φ20	φ25	φ28	φ30	φ32	φ36	φ40
Nominal tensile strength $f_{uk}$ [N/mm <sup>2</sup> ]	B500B	550	550	550	550	550	550	550	550	550	550	550
	B450C	-	-	-	-	518	518	518	-	-	-	-
Yield strength $f_{yk}$ [N/mm <sup>2</sup> ]	B500B	500	500	500	500	500	500	500	500	500	500	500
	B450C	-	-	-	-	450	450	450	-	-	-	-
Stressed cross-section $A_s$ [mm <sup>2</sup> ]	B500B	50,3	78,5	113	154	201	314	491	616	707	804	1018
	B450C	-	-	-	-	201	314	491	-	-	-	-
Moment of resistance $W$ [mm <sup>3</sup> ]	B500B	50,3	98,2	170	269	402	785	1534	2155	2650	3217	4580
	B450C	-	-	-	-	402	785	1534	-	-	-	-

### Material quality

Part	Material
Rebar EN 1992-1-1:2004 and AC:2010	Bars and de-coiled rods class B or C with $f_{yk}$ and $k$ according to NDP or NCL of EN 1992-1-1/ NA:2013 $f_{uk} = f_{tk} = k \cdot f_{yk}$

## Setting information

### Installation temperature range:

-5°C to +40°C

### Service temperature range

Hilti HIT-RE 500 V3 injection mortar may be applied in the temperature ranges given below. An elevated base material temperature may lead to a reduction of the design bond resistance.

Temperature range	Base material temperature	Max. long term base material temperature	Max. short term base material temperature
Temperature range I	-40 °C to + 40 °C	+ 24 °C	+ 40 °C
Temperature range II	-40 °C to + 70 °C	+ 43 °C	+ 70 °C

### Max. short term base material temperature

Short term elevated base material temperatures are those that occur over brief intervals, e.g. as a result of diurnal cycling.

### Max. long term base material temperature

Long term elevated base material temperatures are roughly constant over significant periods of time.

### Working time and curing time

Temperature of the base material	Max. working time in which rebar can be inserted and adjusted $t_{gel}$	Min. curing time before rebar can be fully loaded $t_{cure}^{1)}$
$-5\text{ °C} \leq T_{BM} < -1\text{ °C}$	2 h	168 h
$0\text{ °C} \leq T_{BM} < 4\text{ °C}$	2 h	48 h
$5\text{ °C} \leq T_{BM} < 9\text{ °C}$	2 h	24 h
$10\text{ °C} \leq T_{BM} < 14\text{ °C}$	1,5 h	16 h
$15\text{ °C} \leq T_{BM} < 19\text{ °C}$	1 h	12 h
$20\text{ °C} \leq T_{BM} < 24\text{ °C}$	30 min	7 h
$25\text{ °C} \leq T_{BM} < 29\text{ °C}$	20 min	6 h
$30\text{ °C} \leq T_{BM} < 34\text{ °C}$	15 min	5 h
$35\text{ °C} \leq T_{BM} < 39\text{ °C}$	12 min	4,5 h
$T_{BM} = 40\text{ °C}$	10 min	4 h

1) The curing time data are valid for dry base material only. In wet base material the curing times must be doubled.

### Installation equipment

Rebar – size	φ8	φ10	φ12	φ14	φ16	φ20	φ25	φ28	φ30	φ32	φ36	φ40
Rotary hammer	TE 2 (-A) – TE 40(-A)						TE40 – TE80					
Diamond coring tools	DD EC-1, DD 100 ... DD 160 <sup>a)</sup>											-
Other tools	Compressed air gun, brush, hollow drill bit, roughening tool, dispenser, piston plug											

a) For anchors in diamond drilled holes, load values for combined pull-out and concrete cone resistance have to be reduced (see section "Setting instruction")

### Associated components for the use of Hilti Roughening tool TE-YRT

Diamond coring		Roughening tool TE-YRT	Wear gauge RTG...
$d_0$ [mm]		$d_0$ [mm]	size
Nominal	measured		
18	17,9 to 18,2	18	18
20	19,9 to 20,2	20	20
22	21,9 to 22,2	22	22
25	24,9 to 25,2	25	25
28	27,9 to 28,2	28	28
30	29,9 to 30,2	30	30
32	31,9 to 32,2	32	32
35	34,9 to 35,2	35	35

**Minimum roughening time  $t_{\text{roughen}}$  ( $t_{\text{roughen}} [\text{sec}] = h_{\text{ef}} [\text{mm}] / 10$ )**

$h_{\text{ef}} [\text{mm}]$	$t_{\text{roughen}} [\text{sec}]$
0 to 100	10
101 to 200	20
201 to 300	30
301 to 400	40
401 to 500	50
501 to 600	60

**Setting details**

Anchor size		Ø8	Ø10	Ø12		Ø14	Ø16	Ø20	Ø25	Ø28	Ø30	Ø32	Ø36	Ø40
Nominal diameter of drill bit	$d_0$ [mm]	10 12 <sup>a)</sup>	12 14 <sup>a)</sup>	14 <sup>a)</sup>	16 <sup>a)</sup>	18	20	25	30 32 <sup>a)</sup>	35	37	40	45 <sup>1)</sup>	55 <sup>1)</sup>
Effective anchorage and drill hole depth	$h_{\text{ef,min}}$ [mm]	60	60	70	70	75	80	90	100	112	120	128	144 <sup>1)</sup>	160 <sup>1)</sup>
	$h_{\text{ef,max}}$ [mm]	160	200	240	240	280	320	400	500	560	600	640	720 <sup>1)</sup>	800 <sup>1)</sup>
Minimum base material thickness	$h_{\text{min}}$ [mm]	$h_{\text{ef}} + 30 \text{ mm} \geq 100 \text{ mm}$				$h_{\text{ef}} + 2 d_0$								
Minimum spacing	$s_{\text{min}}$ [mm]	40	50	60	60	70	80	100	125	140	150	160	180 <sup>1)</sup>	200 <sup>1)</sup>
Minimum edge	$c_{\text{min}}$ [mm]	40	45	45	45	50	50	65	70	75	80	80	180 <sup>1)</sup>	200 <sup>1)</sup>
Critical spacing for splitting failure	$s_{\text{cr,sp}}$ [mm]	$2 C_{\text{cr,sp}}$												
Critical edge distance for splitting failure <sup>c)</sup>	$c_{\text{cr,sp}}$ [mm]	$1,0 \cdot h_{\text{ef}}$ for $h / h_{\text{ef}} \geq 2,0$												
		$4,6 h_{\text{ef}} - 1,8 h$ for $2,0 > h / h_{\text{ef}} > 1,3$												
		$2,26 h_{\text{ef}}$ for $h / h_{\text{ef}} \leq 1,3$												
Critical spacing for concrete cone failure	$s_{\text{cr,N}}$ [mm]	$2 C_{\text{cr,N}}$												
Critical edge distance for concrete cone failure <sup>d)</sup>	$c_{\text{cr,N}}$ [mm]	$1,5 h_{\text{ef}}$												

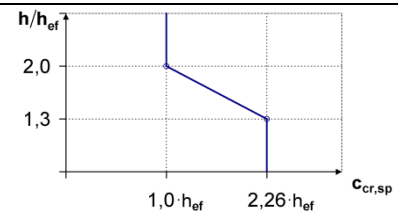





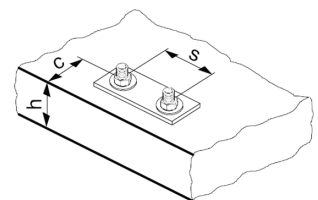

1) Additional Hilti Technical data

For spacing (edge distance) smaller than critical spacing (critical edge distance) the design loads have to be reduced.

- a) both given values for drill bit diameter can be used
- b)  $h_{\text{ef,min}} \leq h_{\text{ef}} \leq h_{\text{ef,max}}$  ( $h_{\text{ef}}$ : embedment depth)
- c)  $h$ : base material thickness ( $h \geq h_{\text{min}}$ )
- d) The critical edge distance for concrete cone failure depends on the embedment depth  $h_{\text{ef}}$  and the design bond resistance. The simplified formula given in this table is on the safe side



### Drilling and cleaning diameters

Rebar - size	Hammer drill (HD)	Hollow Drill Bit (HDB)	Diamond coring		Brush HIT-RB	Piston plug HIT-SZ
			Diamond coring (DD)	With roughening tool (RT)		
	d <sub>0</sub> [mm]				size [mm]	
						
φ8	12 (10 <sup>a</sup> )	-	12 (10 <sup>a</sup> )	-	12 (10 <sup>a</sup> )	12
φ10	14 (12 <sup>a</sup> )	14	14 (12 <sup>a</sup> )	-	14 (12 <sup>a</sup> )	14 (12 <sup>a</sup> )
φ12	16 (14 <sup>a</sup> )	16 (14 <sup>a</sup> )	16 (14 <sup>a</sup> )	-	16 (14 <sup>a</sup> )	16 (14 <sup>a</sup> )
φ14	18	18	18	18	18	18
φ16	20	20	20	20	20	20
φ20	25	25	25	25	25	25
φ25	32	32	32	32	32	32
φ28	35	35	35	35	35	35
φ30	37	-	37	-	37	37
φ32	40	-	-	-	40	40
	-	-	42	-	42	42
φ36	45 <sup>b</sup> )	-	-	-	45 <sup>b</sup> )	45 <sup>b</sup> )
φ40	55 <sup>b</sup> )	-	-	-	55 <sup>b</sup> )	55 <sup>b</sup> )

- a) Each of two given values can be used  
b) Additional Hilti technical data



## Setting instructions

\*For detailed information on installation see instruction for use given with the package of the product.



### Safety regulations.

Review the Material Safety Data Sheet (MSDS) before use for proper and safe handling! Wear well-fitting protective goggles and protective gloves when working with Hilti HIT-RE 500 V3.

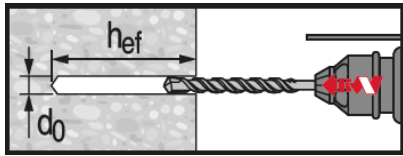

**Hammer drilled hole**

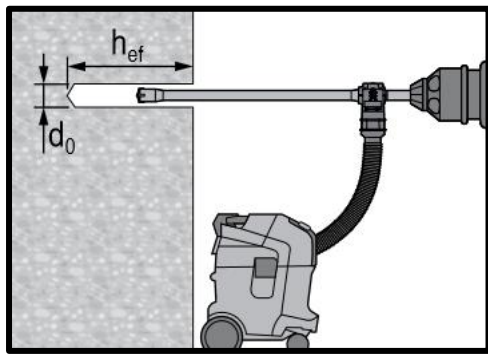

**Hammer drilled hole with Hollow Drilled Bit (HDB)**

No cleaning required

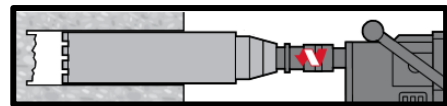

**Diamond Coring**

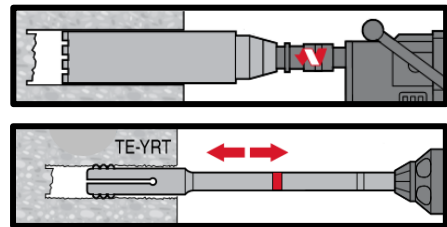

**Diamond Coring + Roughening Tool**

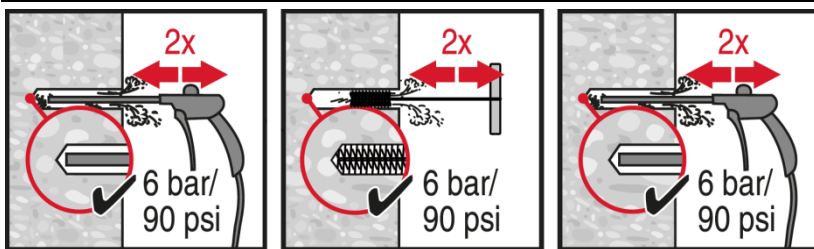

**Hammer Drilling:**

**Compressed air cleaning (CAC)**

for all drill hole diameters  $d_0$  and drill hole depths  $h_0 \leq 20 \cdot d$ .

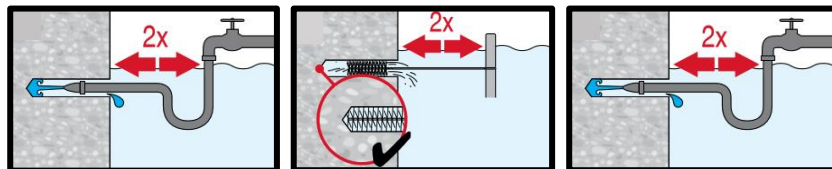

**Hammer drilling:**

**Cleaning for under water:**

For all bore hole diameters  $d_0$  and all bore hole depth  $h_0$ .

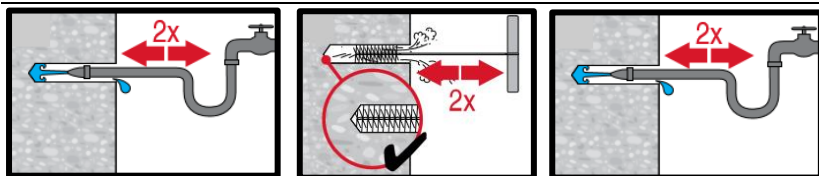

**Hammer drilled flooded holes and diamond cored holes:**

**Compressed air cleaning (CAC)**

for all drill hole diameters  $d_0$  and drill hole depths  $h_0$ .

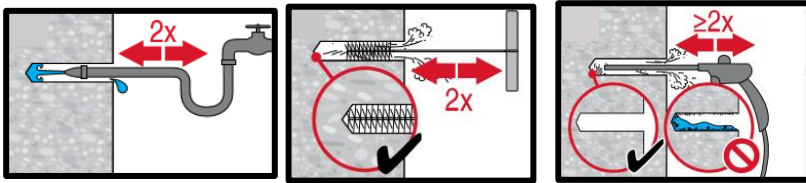
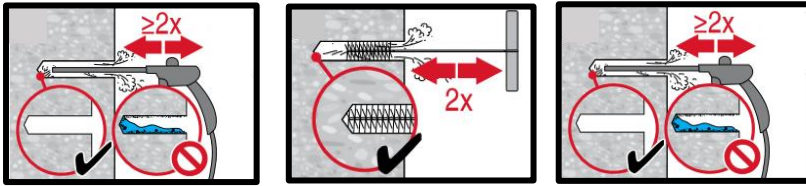

**Diamond cored holes with Hilti roughening tool:**

**Compressed air cleaning (CAC)** for all drill hole diameters  $d_0$  and drill hole depths  $h_0$ .

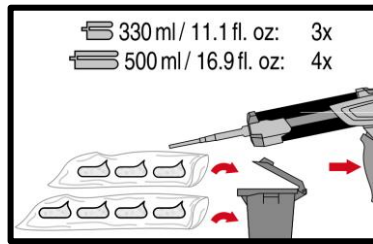
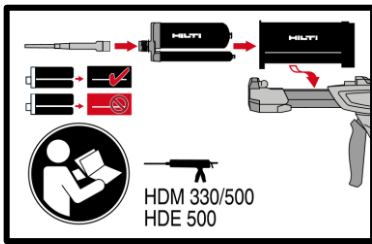

**Injection system preparation.**

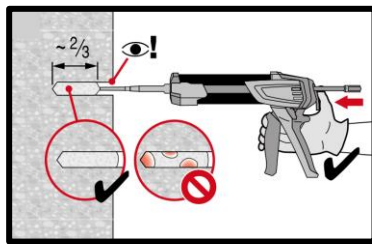
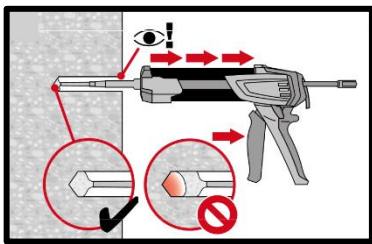

**Injection method for drill hole depth  $h_{ef} \leq 250$  mm.**

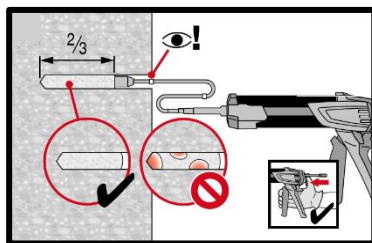
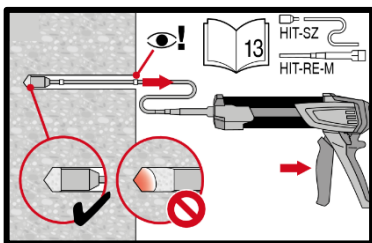

**Injection method for drill hole depth  $h_{ef} > 250$  mm.**

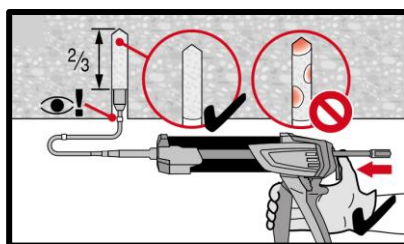
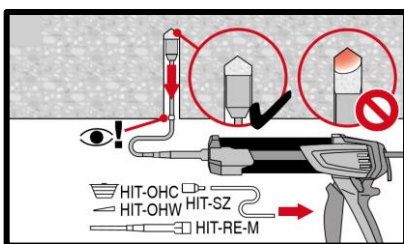

**Injection method for overhead application.**

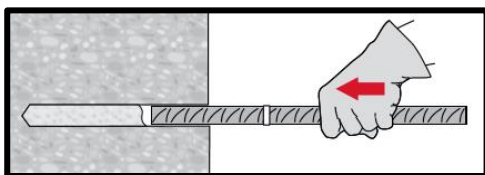

**Setting element**, observe working time " $t_{work}$ ",

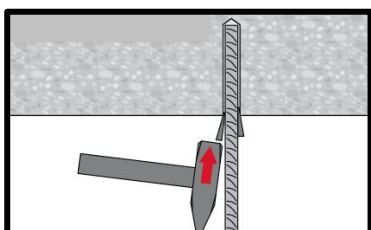

**Setting element for overhead applications**, observe working time " $t_{work}$ ",

**Loading the anchor:** After required curing time  $t_{cure}$  the anchor can be loaded.





# HIT-RE 500 V3 injection mortar

Rebar design (EOTA TR023) / Rebar elements / Concrete

## Injection mortar system



Foil pack: HIT-RE 500 V3  
(available in 330, 500  
and 1400 ml cartridges)



Rebar B500 B  
( $\phi 8$  -  $\phi 40$ )

## Benefits

- **SafeSet** technology: Simplified method of borehole preparation using either Hilti hollow drill bit for hammer drilling or Roughening tool for diamond cored applications
- Suitable for concrete C 12/15 to C 50/60
- High loading capacity
- Suitable for dry and water saturated concrete
- Non-corrosive to rebar elements
- Long working time at elevated temperatures
- Cures down to  $-5^{\circ}\text{C}$
- Odourless epoxy
- Fire time exposure up to 4h

## Base material



Concrete  
(non-cracked)



Concrete  
(cracked)



Dry concrete



Wet concrete

## Load conditions

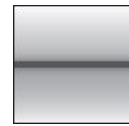

Static/  
quasi-static



Seismic,  
ETA-C1



Fire  
resistance

## Installation conditions

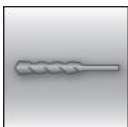

Hammer  
drilling



Diamond  
coring

**SAFESET**

Hilti **SafeSet**  
technology

## Other informations



European  
Technical  
Assessment



CE  
conformity



PROFIS  
Rebar  
design  
Software

## Approvals / certificates

Description	Authority / Laboratory	No. / date of issue
European technical assessment <sup>a)</sup>	CSTB, Marne la Vallée	ETA-16/0142 / 2019-05-27
Fire evaluation	CSTB, Marne la Vallée	MRF 1526054277/B

b) All data given in this section according to ETA-16/0142 issue 2019-05-27.

## Static and quasi-static loading

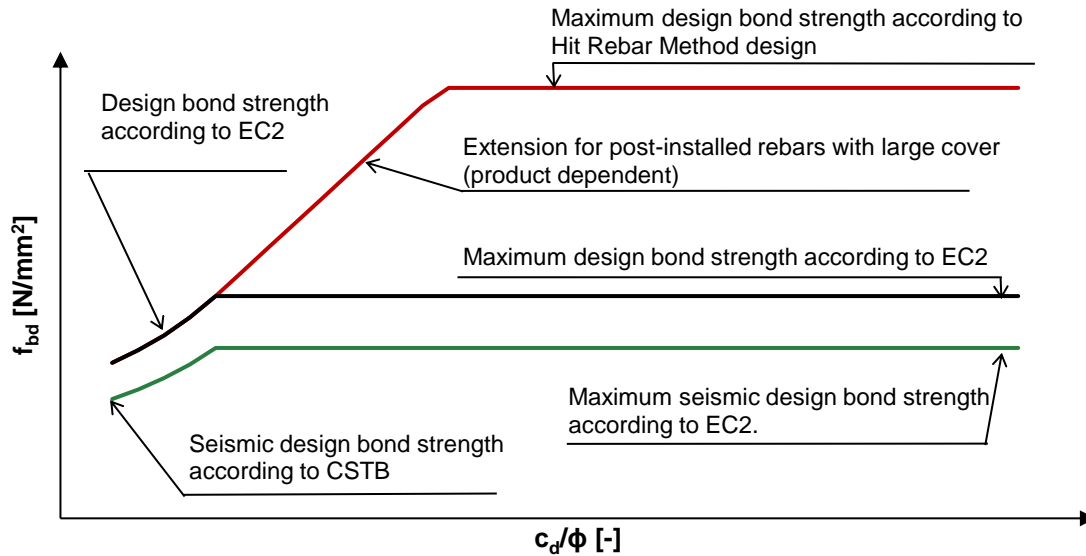

Effective limit on bond stress for post-installed rebar using Hilti mortar systems and design bond strength values as provided by the EC2.

### Static EC2 design, small concrete cover (see section 3.2.1)

#### Design bond strength in N/mm<sup>2</sup> according to ETA 16/0142 for good bond conditions

All allowed hammer drilling methods									
Rebar - size	Concrete class								
	C12/15	C16/20	C20/25	C25/30	C30/37	C35/45	C40/50	C45/55	C50/60
φ8 - φ32	1,6	2,0	2,3	2,7	3,0	3,4	3,7	4,0	4,3
φ34	1,6	2,0	2,3	2,6	2,9	3,3	3,6	3,9	4,2
φ36	1,6	1,9	2,2	2,6	2,9	3,2	3,5	3,8	4,1
φ40	1,5	1,8	2,1	2,5	2,8	3,1	3,4	3,7	3,9
Diamond coring wet									
φ8 - φ12	1,6	2,0	2,3	2,7	3,0	3,4	3,7	4,0	4,0
φ14 - φ 16	1,6	2,0	2,3	2,7	3,0	3,4	3,7	3,7	3,7
φ18 - φ32	1,6	2,0	2,3	2,7	3,0	3,4	3,4	3,4	3,4
φ34	1,6	2,0	2,3	2,6	2,9	3,3	3,3	3,3	3,3
φ36	1,6	1,9	2,2	2,6	2,9	3,2	3,2	3,2	3,2
φ40	1,5	1,8	2,1	2,5	2,8	2,8	2,8	2,8	2,8

For poor bond conditions multiply the values by 0,7.



Static Hit Rebar design method, large concrete cover (see section 3.2.2)

Pullout design bond strength [ $f_{bd,po} = \tau_{Rk}/\gamma_{Mp}$ ] in N/mm<sup>2</sup> for good bond conditions

Non-cracked concrete C20/25, all allowed drilling methods													
Temperature range	Drilling method	Rebar - size											
		φ8	φ10	φ12	φ14	φ16	φ20	φ25	φ28	φ30	φ32	φ36	φ40
I: 40°C/24° C	Hammer drilled holes	6,3	9,5	9,5	9,5	9,5	9,5	8,7	8,7	8,7	8,7	6,7	7,9
	Hammer drilled holes with hollow drill bit	-	-	9,5	9,5	9,5	9,5	8,7	8,7	-	-	-	-
	Diamond cored holes with roughening tool	-	-	-	9,5	9,5	9,5	8,7	8,7	-	-	-	-
	Diamond cored holes	5	5	5	5	5	5	5	5,3	5,3	5,3	-	-
	Hammer drilled holes in water filled holes	3,8	5,7	5,7	5,7	5,7	5,7	5,2	5,2	5,2	5,2	-	-
II: 70°C/43° C	Hammer drilled holes	4,7	7,3	7,3	7,3	6,7	6,7	6,7	6,3	6,3	6,3	5,7	5,0
	Hammer drilled holes with hollow drill bit	-	-	7,3	7,3	6,7	6,7	6,7	6,3	-	-	-	-
	Diamond cored holes with roughening tool	-	-	-	7,3	6,7	6,7	6,7	6,3	-	-	-	-
	Diamond cored holes	3,6	3,6	3,6	3,6	3,1	3,3	3,3	3,3	3,3	3,3	-	-
	Hammer drilled holes in water filled holes	2,6	4,3	4,3	4,3	4,3	4,0	4,0	4,0	3,8	3,8	-	-
Cracked concrete C20/25, all allowed drilling methods													
I: 40°C/24° C	Hammer drilled holes	3	5,7	6,3	6,3	6,3	6,7	6,7	7,3	7,3	7,3		
	Hammer drilled holes with hollow drill bit	-	-	6,3	6,3	6,3	6,7	6,7	7,3	-	-	-	-
	Diamond cored holes with roughening tool	-	-	-	6,3	6,3	6,7	6,7	7,3	-	-	-	-
II: 70°C/43° C	Hammer drilled holes	2,7	4,7	5,3	5,3	5,3	5,3	5,3	5,3	5,3	5,3		
	Hammer drilled holes with hollow drill bit	-	-		5,3	5,3	5,3	5,3	5,3	-	-	-	-
	Diamond cored holes with roughening tool	-	-	-	5,3	5,3	5,3	5,3	5,3	-	-	-	-

For poor bond conditions multiply values by 0,7.

Increasing factors in concrete for  $f_{bd,po}$

Drilling method	Concrete class	Rebar-size											
		φ8	φ10	φ12	φ14	φ16	φ20	φ25	φ28	φ30	φ32	φ36	φ40
Hammer drilled holes	C 30/37	1,04											
Hammer drilled holes with hollow drill bit	C40/50	1,07											
Diamond cored holes	C50/60	1,09											
Diamond cored holes with roughening tool	C 30/37 - C50/60	1,0										-	

## Minimum anchorage length and minimum lap length

The minimum anchorage length  $l_{b,min}$  and the minimum lap length  $l_{0,min}$  according to EN 1992-1-1 shall be multiplied by relevant **Amplification factor  $\alpha_{lb}$**  in the table below.

### Amplification factor $\alpha_{lb}$ for the min. anchorage length and min. lap length

All allowed hammer drilling methods and diamond coring with Hilti roughening tool TE-YRT									
Rebar - size	Concrete class								
	C12/15	C16/20	C20/25	C25/30	C30/37	C35/45	C40/50	C45/55	C50/60
$\phi 8 - \phi 40$	1,0								
Diamond coring wet									
$\phi 8 - \phi 12$	1,0								
$\phi 14 - \phi 36$	Linear interpolation between diameters								
$\phi 40$	1,0	1,0	1,0	1,0	1,2	1,3	1,4	1,4	1,4

### Anchorage length for characteristic steel strength $f_{yk}=500 \text{ N/mm}^2$ for good conditions

Hammer drilling									
Rebar-size	Concrete class	$f_{bd}$	$f_{bd,p}$	$l_{0,min}^{1)}$	$l_{b,min}^{2)}$	$l_{bd,y,\alpha_2=1}^{3)}$	$l_{bd,y,\alpha_2=0.7}^{4)}$	$l_{bd,y,HRM,\alpha_2<0.7}^{5)}$	$l_{max}^{6)}$
		[N/mm <sup>2</sup> ]	[N/mm <sup>2</sup> ]	[mm]	[mm]	[mm]	[mm]	[mm]	[mm]
$\phi 8$	C20/25	2,3	6,3	200	113	378	265	138	1000
	C50/60	4,3	6,9	200	100	202	142	126	1000
$\phi 10$	C20/25	2,3	9,3	213	142	473	331	142	1000
	C50/60	4,3	10,2	200	100	253	177	107	1000
$\phi 12$	C20/25	2,3	9,3	255	170	567	397	170	1200
	C50/60	4,3	10,2	200	120	303	212	128	1200
$\phi 14$	C20/25	2,3	9,3	298	198	662	463	198	1400
	C50/60	4,3	10,2	210	140	354	248	149	1400
$\phi 16$	C20/25	2,3	9,3	340	227	756	529	234	1600
	C50/60	4,3	10,2	240	160	404	283	171	1600
$\phi 20$	C20/25	2,3	9,3	435	284	945	662	356	2000
	C50/60	4,3	10,2	300	200	506	354	213	2000
$\phi 25$	C20/25	2,3	8,7	532	354	1181	827	539	2500
	C50/60	4,3	9,4	375	250	632	442	289	2500
$\phi 28$	C20/25	2,3	8,7	595	397	1323	926	663	2800
	C50/60	4,3	9,4	420	280	708	495	354	2800
$\phi 30$	C20/25	2,3	8,7	638	425	1418	992	751	3000
	C50/60	4,3	9,4	450	300	758	531	402	3000
$\phi 32$	C20/25	2,3	8,7	681	454	1512	1059	844	3200
	C50/60	4,3	9,4	480	320	809	566	451	3200
$\phi 36$	C20/25	2,2	5,2	534	540	1779	1245	753	3200
	C50/60	3,2	5,7	367	540	1223	856	686	3200
$\phi 40$	C20/25	2,1	4,8	621	621	2070	1449	906	3200
	C50/60	2,8	5,2	466	600	1553	1087	836	3200

1) Minimum anchorage length for overlap joint

2) Minimum anchorage length for simply supported connections

3) Anchorage length for simply supported connections in case of:  $\alpha_1 = \alpha_2 = \alpha_3 = \alpha_4 = \alpha_5 = 1$ . - (design for yielding)

4) Anchorage length for simply supported connections in case of:  $\alpha_1 = \alpha_3 = \alpha_4 = \alpha_5 = 1$ ;  $\alpha_2 = 0.7$  - (design for yielding)

5) Anchorage length with HIT Rebar design Method (HRM) for simply supported connections in case of:  $\alpha_1 = \alpha_3 = \alpha_4 = \alpha_5 = 1$ ;  $\alpha_2 < 0.7$ . Only if an adequate concrete cover is applied.

6) Maximum feasible embedment depth due to mortar installation limitations.





## Seismic loading

### Seismic data according to ETA-16/0142

#### Design bond strength in N/mm<sup>2</sup> for good bond conditions

All allowed hammer drilling methods, diamond coring dry and diamond coring with Hilti roughening tool TE-YRT

Rebar - size	Concrete class							
	C16/20	C20/25	C25/30	C30/37	C35/45	C40/50	C45/55	C50/60
φ10 - φ32	2,0	2,3	2,7	3,0	3,4	3,7	4,0	4,3
φ34	2,0	2,3	2,6	2,9	3,3	3,6	3,9	4,2
φ36	1,9	2,2	2,6	2,9	3,2	3,5	3,8	4,1
φ40	1,8	2,1	2,5	2,8	3,1	3,4	3,7	3,9

For poor bond conditions multiply the values 0,7.

#### Design bond strength in N/mm<sup>2</sup> for good bond conditions

Diamond coring wet

Rebar - size	Concrete class							
	C16/20	C20/25	C25/30	C30/37	C35/45	C40/50	C45/55	C50/60
φ12	2,0	2,3	2,7	3,0	3,4	3,7	4,0	4,0
φ14 - φ32	2,0	2,3	2,7	3,0	3,3	3,4	3,4	3,4
φ34	1,9	2,3	2,3	2,3	2,3	2,3	2,3	2,3
φ36	1,9	2,2	2,2	2,2	2,2	2,2	2,2	2,2
φ40	1,8	2,1	2,1	2,1	2,1	2,1	2,1	2,1

For poor bond conditions multiply the values 0,7.

## Fire resistance

### Temperature reduction factor $k_{fi}(\theta)$

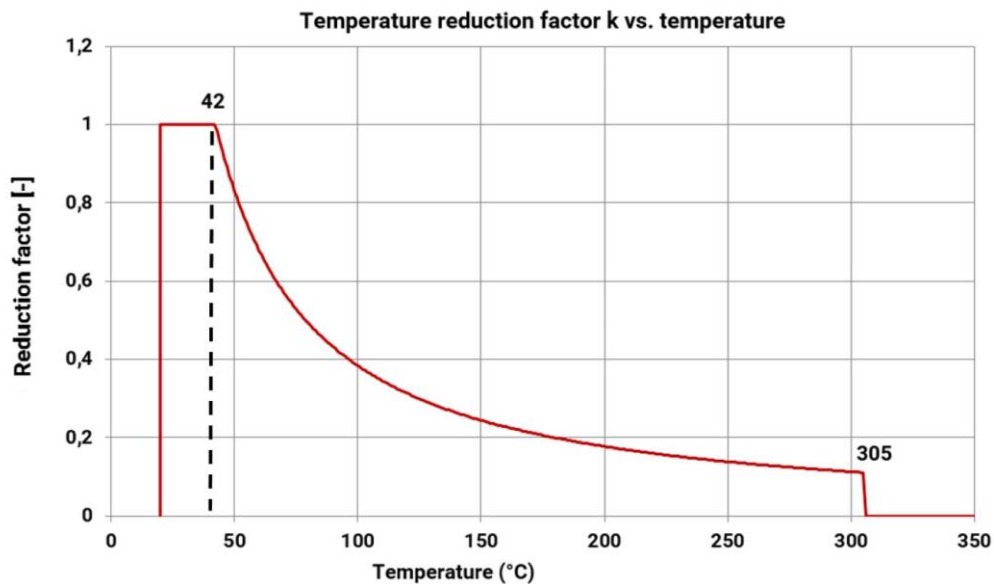

The design value of the bond resistance  $f_{bd,fi}$  under fire exposure has to be calculated by the following equation:

$$f_{bd,fi} = k_{b,fi}(\theta) \cdot f_{bd} \cdot \frac{\gamma_c}{\gamma_{M,fi}}$$

If  $\theta > 42^\circ\text{C}$ :

$$k_{b,fi}(\theta) = \frac{651.24 \cdot \theta^{-1.115}}{f_{bd} \cdot 4.3} \leq 1.0$$

If  $\theta > 305^\circ\text{C}$ :

$$k_{b,fi}(\theta) = 0.0$$

$f_{bd,fi}$  = Design value of the bond resistance in case of fire in N/mm<sup>2</sup>

$(\theta)$  = Temperature in °C in the mortar layer.

$k_{b,fi}(\theta)$  = Reduction factor under fire exposure.

$f_{bd,fi}(\theta)$  = Design value of the bond resistance in N/mm<sup>2</sup> in cold condition according to Table C2 or C3 considering the concrete classes, the rebar diameter, the drilling method and the bond conditions according to EN 1992-1-1.

$\gamma_c$  = Partial safety factor according to EN 1992-1-1

$\gamma_{M,fi}$  = Partial safety factor according to EN 1992-1-2

For evidence under fire exposure the anchorage length shall be calculated according to EN 1992-1-1:2004+AC:2010 Equation 8.3 using the temperature-dependent bond resistance  $f_{bd,fi}$ .

According to MRF 1526054277 / B

a) Anchoring application

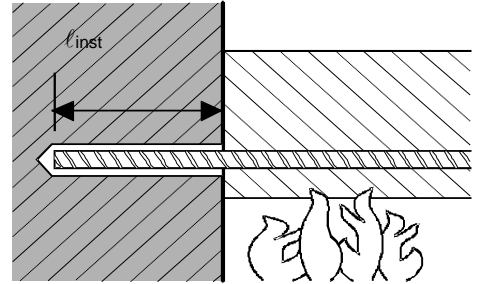

Anchoring application beam-wall connection with a concrete cover of 20 mm

Maximum force in rebar in conjunction with HIT-RE 500 V3 as a function of embedment depth for the fire resistance classes F30 to F240 (yield strength  $f_{yk} = 500 \text{ N/mm}^2$  and concrete class C20/25) according EC2

Rebar-size	Max. $F_{s,T}$ [kN]	$l_{inst}$ [mm]	Fire resistance of bar in [kN]					
			R30	R60	R90	R120	R180	R240
$\phi 8$	16,8	100	3,8	1,3	0,5	0,2	0,0	0,0
		140	7,2	4,3	2,3	1,5	0,7	0,2
		180	10,7	7,8	5,6	3,9	2,1	1,3
		220	14,2	11,2	9,1	7,4	4,6	2,9
		250	16,8	13,8	11,7	10,0	7,1	4,8
		290			15,1	13,5	10,6	8,1
		310	16,8	16,8	16,8	15,2	12,3	9,8
		330				16,8	14,0	11,6
		370						
		390				16,8		
$\phi 10$	26,2	110	5,8	2,4	1,1	0,6	0,0	0,0
		150	10,1	6,5	3,8	2,5	1,2	0,5
		190	14,5	10,8	8,1	6,0	3,3	2,0
		230	18,8	15,1	12,4	10,3	6,7	4,4
		300	26,2	22,7	20,0	17,9	14,3	11,2
		340			24,3	22,2	18,6	15,6
		360	26,2	26,2	26,2	24,4	20,8	17,7
		380				23,0	19,9	
		410						23,1
		440				26,2		
$\phi 12$	37,7	140	10,9	6,5	3,5	2,3	1,0	0,3
		200	18,7	14,3	11,0	8,5	4,8	3,0
		260	26,5	22,1	18,8	16,3	12,0	8,3
		320	34,3	29,9	26,6	24,1	19,8	16,1
		350	37,7	33,8	30,5	28,0	23,7	20,0
		390			35,7	33,2	28,9	25,2
		410	37,7	37,7	37,7	35,8	31,5	27,8
		430				34,1	30,4	
		460						34,3
		490				37,7		
$\phi 14$	51,3	160	15,7	10,6	6,7	4,4	2,3	1,1
		220	24,8	19,7	15,8	12,9	8,0	5,1
		280	33,9	28,8	24,9	22,0	17,0	12,7
		340	43,0	37,9	34,1	31,1	26,1	21,8
		400	51,3	47,0	43,2	40,2	35,2	30,9
		430			47,7	44,8	39,7	35,4
		460	51,3	51,3	51,3	49,3	44,3	40,0
		480				47,3	43,0	
		510						47,6
		540				51,3		
$\phi 16$	67	180	21,4	15,5	11,2	7,8	4,3	2,5
		240	31,8	25,9	21,6	18,2	12,5	8,2
		300	42,2	36,3	32,0	28,6	22,9	18,0
		360	52,6	46,8	42,4	39,0	33,3	28,4
		450	67,0	62,4	58,0	54,6	48,9	44,0

Maximum force in rebar in conjunction with HIT-RE 500 V3 as a function of embedment depth for the fire resistance classes F30 to F240 (yield strength  $f_{yk} = 500 \text{ N/mm}^2$  and concrete class C20/25) according EC2

Rebar-size	Max. $F_{s,T}$ [kN]	$l_{inst}$ [mm]	Fire resistance of bar in [kN]					
			R30	R60	R90	R120	R180	R240
		480		67,0	63,2	59,8	54,1	49,2
		510			65,1	59,3	54,4	
		530			67,0	62,8	57,8	
		560				67,0	63,0	
		590					67,0	
$\phi 20$	104,7	220	35,5	28,1	22,6	18,5	11,4	7,3
		280	48,5	41,1	35,6	31,5	24,3	18,1
		340	61,5	54,1	48,6	44,5	37,3	31,1
		400	74,5	67,1	61,7	57,5	50,3	44,1
		460	87,5	80,1	74,7	70,5	63,3	57,1
		540	104,7	97,5	92,0	87,8	80,6	74,5
		580		104,7	100,7	96,5	89,3	83,1
		600			100,8	93,6	87,5	
		620	104,7	104,7	104,7	104,7	98,0	91,8
		660					104,7	100,5
		680				104,7		104,7

Anchoring application beam-wall connection with a concrete cover of 40 mm

Rebar-size	Max. F <sub>s,T</sub> [kN]	l <sub>inst</sub> [mm]	Fire resistance of bar in [kN]					
			R30	R60	R90	R120	R180	R240
φ8	16,8	100	4,9	1,8	0,8	0,4	0,0	0,0
		140	8,4	5,0	2,9	1,9	0,7	0,2
		180	11,9	8,5	6,2	4,5	2,3	1,3
		220	15,4	11,9	9,7	8,0	4,9	3,1
		240	16,8	13,7	11,4	9,7	6,6	4,3
		280		16,8	14,9	13,2	10,1	7,6
		310	16,8		16,8	15,8	12,7	10,2
		330		16,8		16,8	14,4	11,9
		360	16,8		16,8		16,8	14,5
		390		16,8		16,8	16,8	16,8
φ10	26,2	110	7,3		3,1		1,5	0,9
		150	11,6	7,3	4,5	3,0	1,3	0,6
		190	15,9	11,7	8,9	6,7	3,5	2,1
		230	20,3	16,0	13,2	11,0	7,2	4,6
		290	26,2	22,5	19,7	17,5	13,7	10,5
		330		26,2	24,0	21,9	18,0	14,9
		350	26,2		26,2	24,0	20,2	17,0
		370		26,2		26,2	22,3	19,2
		410	26,2		26,2		26,2	23,6
		440		26,2		26,2	26,2	26,2
φ12	37,7	140	12,6		7,5		4,3	2,8
		200	20,4	15,3	11,9	9,3	5,2	3,2
		260	28,2	23,1	19,7	17,1	12,5	8,8
		320	36,0	30,9	27,6	25,0	20,3	16,6
		340	37,7	33,5	30,2	27,6	22,9	19,2
		380		37,7	35,4	32,8	28,1	24,4
		400	37,7		37,7	35,4	30,7	27,0
		420		37,7		37,7	33,3	29,6
		460	37,7		37,7		37,7	34,8
		490		37,7		37,7	37,7	37,7
φ14	51,3	160	17,8		11,8		7,9	5,2
		220	26,9	20,9	17,0	13,9	8,5	5,5
		280	36,0	30,0	26,1	23,0	17,6	13,2
		340	45,1	39,1	35,2	32,1	26,7	22,4
		390	51,3	46,7	42,8	39,7	34,3	29,9
		430		51,3	48,8	45,8	40,4	36,0
		450	51,3		51,3	48,8	43,4	39,0
		470		51,3		51,3	46,4	42,1
		510	51,3		51,3		51,3	48,1
		540		51,3		51,3	51,3	51,3
φ16	67	180	23,8		16,9		12,5	9,0
		240	34,2	27,3	22,9	19,4	13,2	8,7
		300	44,6	37,7	33,3	29,8	23,6	18,6
		360	55,0	48,2	43,7	40,2	34,0	29,0
		430	67,0	60,3	55,8	52,3	46,1	41,2
		470		67,0	62,7	59,3	53,1	48,1
		500	67,0		67,0	64,5	58,3	53,3
		520		67,0		67,0	61,7	56,8
		560	67,0		67,0		67,0	63,7
		580		67,0		67,0	67,0	67,0

Rebar-size	Max. F <sub>s,T</sub> [kN]	l <sub>inst</sub> [mm]	Fire resistance of bar in [kN]					
			R30	R60	R90	R120	R180	R240
φ20	104,7	220	38,4	29,8	24,2	19,9	12,2	7,8
		300	55,7	47,2	41,6	37,3	29,5	23,3
		380	73,1	64,5	58,9	54,6	46,8	40,6
		460	90,4	81,9	76,3	71,9	64,2	57,9
		530	104,7	97,0	91,4	87,1	79,3	73,1
		570		100,1	95,8	88,0	81,8	
		600	104,7	104,7	104,7	102,3	94,5	88,3
		620				98,9	92,6	
		650				104,7	99,1	
		680				104,7	104,7	
φ25	163,6	280	64,2	53,6	46,6	41,1	31,4	23,7
		370	88,6	77,9	70,9	65,5	55,8	48,0
		460	113,0	102,3	95,3	89,9	80,2	72,4
		550	137,4	126,7	119,7	114,3	104,6	96,8
		650	163,6	153,8	146,8	141,4	131,7	123,9
		690		157,7	152,2	142,5	134,7	
		720	163,6	163,6	163,6	160,4	150,7	142,9
		740				156,1	148,3	
		770				163,6	156,4	
		800				163,6	163,6	
φ28	205,3	310	81,1	69,1	61,3	55,2	44,3	35,6
		370	99,3	87,3	79,5	73,4	62,5	53,8
		430	117,5	105,5	97,7	91,6	80,7	72,0
		490	135,7	123,7	115,9	109,8	98,9	90,2
		550	153,9	141,9	134,1	128,0	117,2	108,4
		610	172,1	160,1	152,3	146,2	135,4	126,6
		670	190,3	178,3	170,5	164,4	153,6	144,8
		720	205,3	193,5	185,7	179,6	168,7	160,0
		760		197,8	191,8	180,9	172,2	
		790	205,3	205,3	205,3	200,9	190,0	181,3
		810				196,1	187,3	
		850				205,3	199,5	
		870				205,3	205,3	
φ32	268,1	350	106,5	92,8	83,9	76,9	64,5	54,6
		410	127,3	113,6	104,7	97,8	85,3	75,4
		470	148,1	134,5	125,5	118,6	106,1	96,2
		530	168,9	155,3	146,3	139,4	127,0	117,0
		590	189,7	176,1	167,1	160,2	147,8	137,8
		650	210,6	196,9	187,9	181,0	168,6	158,6
		710	231,4	217,7	208,7	201,8	189,4	179,4
		820	268,1	255,8	246,9	240,0	227,5	217,6
		860		260,8	253,8	241,4	231,4	
		890	268,1	268,1	268,1	264,2	251,8	241,8
		910				258,7	248,8	
		940				268,1	259,2	
		970				268,1	268,1	

### b) Overlap joint application

Max. bond stress,  $f_{bd,FIRE}$ , depending on actual clear concrete cover for classifying the fire resistance.

It must be verified that the actual force in the bar during a fire,  $F_{s,T}$ , can be taken up by the bar connection of the selected length,  $l_{inst}$ . Note: Cold design for ULS is mandatory.

$$F_{s,T} \leq (l_{inst} - c_f) \cdot \phi \cdot \pi \cdot f_{bd,FIRE} \quad \text{where: } (l_{inst} - c_f) \geq l_s;$$

$l_s$  = lap length

$\phi$  = nominal diameter of bar

$l_{inst} - c_f$  = selected overlap joint length; this must be at least  $l_s$ ,

but may not be assumed to be more than  $80 \phi$

$f_{bd,FIRE}$  = bond stress when exposed to fire

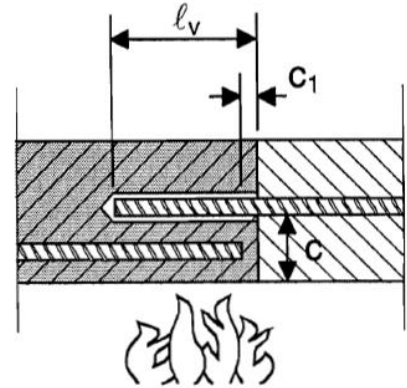

**Critical temperature-dependent bond stress,  $f_{bd,FIRE}$ , concerning “overlap joint” for Hilti HIT-RE 500 V3 injection adhesive in relation to fire resistance class and required minimum concrete coverage c.**

Clear concrete cover c [mm]	Max. bond stress, $\tau_c$ [N/mm <sup>2</sup> ]					
	R30	R60	R90	R120	R180	R240
30						
40	0,8					
50	1,1					
60	1,5					
70	2,1	0,9				
80	2,9	1,2				
90	3,5	1,5	0,9			
100		1,8	1,1	0,8		
110		2,3	1,4	1,0		
120		2,8	1,6	1,2		
130		3,4	2,0	1,4	0,9	
140		3,5	2,3	1,6	1,0	
150			2,8	1,9	1,1	0,8
160			3,3	2,2	1,3	0,9
170			3,5	2,5	1,5	1,1
180				2,9	1,7	1,2
190				3,4	1,9	1,4
200				3,5	2,2	1,5
210					2,5	1,7
220					2,8	1,9
230					3,1	2,1
240					3,5	2,3
250						2,6
260						2,9
270						3,2
280						3,5
290						



## Materials

### Properties of reinforcement

Designation	Material
Reinforcing bars (rebars)	
Rebar EN 1992-1-1	Bars and de-coiled rods class B or C with $f_{yk}$ and $k$ according to NDP or NCL of EN 1992-1-1 $f_{uk} = f_{tk} = k \cdot f_{yk}$

### Fitness for use

Some creep tests have been conducted in accordance with ETAG guideline 001 part 5 and TR 023 in the following conditions: **in dry environment at 50 °C during 90 days.**

These tests show an excellent behaviour of the post-installed connection made with HIT-RE 500 V3: low displacements with long term stability, failure load after exposure above reference load.

### Resistance to chemical substances

Chemicals tested	Content (%)	Resistance	Chemical tested	Content (%)	Resistance
Toluene	47,5	+	Sodium hydroxide 20%	100	-
Iso-octane	30,4	+	Triethanolamine	50	-
Heptane	17,1	+	Butylamine	50	-
Methanol	3	+	Benzyl alcohol	100	-
Butanol	2	+	Ethanol	100	-
Toluene	60	+	Ethyl acetate	100	-
Xylene	30	+	Methyl ethyl ketone (MEK)	100	-
Methylnaphthalene	10	+	Trichlorethylene	100	-
Diesel	100	+	Lutensit TC KLC 50	3	+
Petrol	100	+	Marlophen NP 9,5	2	+
Methanol	100	-	Water	95	+
Dichloromethane	100	-	Tetrahydrofurane	100	-
Mono-chlorobenzene	100	o	Demineralized water	100	+
Ethylacetat	50	-	Salt water	saturated	+
Methylisobutylketone	50	-	Salt spray testing	-	+
Salicylic acid-	50	+	SO <sub>2</sub>	-	+
Acetophenon	50	+	Enviroment/wheather	-	+
Acetic acid	50	-	Oil for formwork (forming oil)	100	+
Propionic acid	50	-	Concentrate plasticizer	-	+
Sulfuric acid	100	-	Concrete potash solution	-	+
Nitric acid	100	-	Concrete potash solution	-	+
Hydrochloric acid	36	-	Saturated suspension of borehole cuttings	-	+
Potassium hydroxide	100	-			

- + Resistant
- Not resistant
- o Partially Resistant

### Electrical Conductivity

HIT-RE 500 V3 in the hardened state **is not conductive electrically**. Its electric resistivity is  $66 \cdot 10^{12} \Omega \cdot m$  (DIN IEC 93 – 12.93). It is adapted well to realize electrically insulating anchorings (ex: railway applications, subway).

### Installation temperature range

-5°C to +40°C

### Service temperature range

Hilti HIT-RE 500 V3 injection mortar may be applied in the temperature ranges given below. An elevated base material temperature may lead to a reduction of the design bond resistance.

Temperature range	Base material temperature	Maximum long term base material temperature	Maximum short term base material temperature
Temperature range I	-40 °C to +80 °C	+50 °C	+80 °C

### Max short term base material temperature

Short-term elevated base material temperatures are those that occur over brief intervals, e.g. as result of diurnal cycling.

### Max long term base material temperature

Long-term elevated base material temperatures are roughly constant over significant periods of time.

### Working time and curing time <sup>1)</sup>

Temperature of the base material	Working time in which rebar can be inserted and adjusted $t_{gel}$	Initial curing time $t_{cure,ini}$	Curing time before rebar can be fully loaded $t_{cure}$
$5\text{ °C} \leq T_{BM} < -1\text{ °C}$	2 h	48 h	168 h
$0\text{ °C} \leq T_{BM} < 4\text{ °C}$	2 h	24 h	48 h
$5\text{ °C} \leq T_{BM} < 9\text{ °C}$	2 h	16 h	24 h
$10\text{ °C} \leq T_{BM} < 14\text{ °C}$	1,5 h	12 h	16 h
$15\text{ °C} \leq T_{BM} < 19\text{ °C}$	1 h	8 h	16 h
$20\text{ °C} \leq T_{BM} < 24\text{ °C}$	30 min	4 h	7 h
$25\text{ °C} \leq T_{BM} < 29\text{ °C}$	20 min	3,5 h	6 h
$30\text{ °C} \leq T_{BM} < 34\text{ °C}$	15 min	3 h	5 h
$35\text{ °C} \leq T_{BM} < 39\text{ °C}$	12 min	2 h	4,5 h
$T_{BM} = 40\text{ °C}$	10 min	2 h	4 h

1) The curing time data are valid for dry base material only. In wet base material the curing times must be doubled.

### Setting information

#### Installation equipment

Rebar – size	φ8	φ10	φ12	φ14	φ16	φ18	φ20	φ25	φ28	φ32	φ34	φ36	φ40
Rotary hammer	TE 2 (-A)– TE 40(-A)						TE40 – TE80						
Other tools	Blow out pump ( $h_{ef} \leq 10 \cdot d$ )						Compressed air gun <sup>a)</sup> Set of cleaning brushes <sup>b)</sup> , dispenser, piston plug Roughening tools						

a) Compressed air gun with extension hose for all drill holes deeper than 250 mm (for φ 8 to φ 12) or deeper than  $20 \cdot \phi$  (for φ > 12 mm)

b) Automatic brushing with round brush for all drill holes deeper than 250 mm (for φ 8 to φ 12) or deeper than  $20 \cdot \phi$  (for φ > 12 mm).

### Minimum concrete cover $c_{min}$ of the post-installed rebar

Drilling method	Bar diameter [mm]	Minimum concrete cover $c_{min}$ [mm]	
		Without drilling aid	With drilling aid
Hammer drilling (HD) and (HDB)	$\phi < 25$	$30 + 0,06 \cdot l_v \geq 2 \cdot \phi$	$30 + 0,02 \cdot l_v \geq 2 \cdot \phi$
	$\phi \geq 25$	$40 + 0,06 \cdot l_v \geq 2 \cdot \phi$	$40 + 0,02 \cdot l_v \geq 2 \cdot \phi$
Compressed air drilling (CA)	$\phi < 25$	$50 + 0,08 \cdot l_v$	$50 + 0,02 \cdot l_v$
	$\phi \geq 25$	$60 + 0,08 \cdot l_v \geq 2 \cdot \phi$	$60 + 0,02 \cdot l_v \geq 2 \cdot \phi$
Diamond coring in wet (PCC) dry (DD)	$\phi < 25$	Drill stand works like a drilling aid	$30 + 0,02 \cdot l_v \geq 2 \cdot \phi$
	$\phi \geq 25$		$40 + 0,02 \cdot l_v \geq 2 \cdot \phi$
Diamond coring with Roughening too	$\phi < 25$	$30 + 0,06 \cdot l_v \geq 2 \cdot \phi$	$30 + 0,02 \cdot l_v \geq 2 \cdot \phi$
	$\phi \geq 25$	$40 + 0,06 \cdot l_v \geq 2 \cdot \phi$	$40 + 0,02 \cdot l_v \geq 2 \cdot \phi$

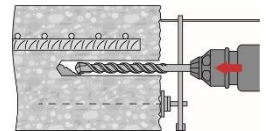

**Dispenser and corresponding maximum embedment depth  $l_{v,max}$** 

Rebar – size [mm]	HDM 330, HDM 500	HDE 500
	$l_{v,max}$ [mm]	
φ8	1000	1000
φ10	1000	1000
φ12	1000	1200
φ14	1000	1400
φ16	1000	1600
φ18	700	1800
φ20	600	2000
φ22	500	1800
φ24	300	1300
φ25	300	1500
φ26	300	1000
φ28	300	1000
φ30	-	1000
φ32		700
φ34		600
φ36		600
φ40		400

**Drilling diameters**

Rebar - size	Hammer drill (HD)	Hollow Drill Bit (HDB) <sup>b)</sup>	Compressed air drill (CA)	Diamond coring		
				Dry (PCC) <sup>b)</sup>	Wet (DD)	With roughening tool (RT) <sup>b)</sup>
$d_0$ [mm]						
φ8	12 (10 <sup>a)</sup> )	-	-	-	12 (10 <sup>a)</sup> )	-
φ10	14 (12 <sup>a)</sup> )	14 (12 <sup>a)</sup> )	-	-	14 (12 <sup>a)</sup> )	-
φ12	16 (14 <sup>a)</sup> )	16 (14 <sup>a)</sup> )	17	-	16 (14 <sup>a)</sup> )	-
φ14	18	18	17	-	18	18
φ16	20	20	20	-	20	20
φ18	22	22	22	-	22	22
φ20	25	25	26	-	25	25
φ22	28	28	28	-	28	28
φ24	32 (30 <sup>a)</sup> )	32 (30 <sup>a)</sup> )	32	-	32	32
φ25	32 (30 <sup>a)</sup> )	32 (30 <sup>a)</sup> )	32	-	32	32
φ26	35	35	35	35	35	35
φ28	35	35	35	35	35	35
φ30	37	-	37	35	37	-
φ32	40	-	40	47	40	-
φ34	45	-	42	47	45	-
φ36	45	-	45	47	47	-
φ40	55	-	57	52	52	-

a) Each of two given values can be used.

b) No cleaning required.

Associated components for the use of Hilti Roughening tool TE-YRT

Diamond coring		Roughening tool TE-YRT	Wear gauge RTG...
d <sub>0</sub> [mm]		d <sub>0</sub> [mm]	size
Nominal	measured		
18	17,9 to 18,2	18	18
20	19,9 to 20,2	20	20
22	21,9 to 22,2	22	22
25	24,9 to 25,2	25	25
28	27,9 to 28,2	28	28
30	29,9 to 30,2	30	30
32	31,9 to 32,2	32	32
35	34,9 to 35,2	35	35

Minimum roughening time t<sub>roughen</sub> (t<sub>roughen</sub> [sec] = h<sub>ef</sub> [mm] / 10)

h <sub>ef</sub> [mm]	t <sub>roughen</sub> [sec]
0 to 100	10
101 to 200	20
201 to 300	30
301 to 400	40
401 to 500	50
501 to 600	60

Setting instructions

\*For detailed information on installation see instruction for use given with the package of the product.



Safety regulations.

Review the Material Safety Data Sheet (MSDS) before use for proper and safe handling! Wear well-fitting protective goggles and protective gloves when working with Hilti HIT-RE 500 V3.

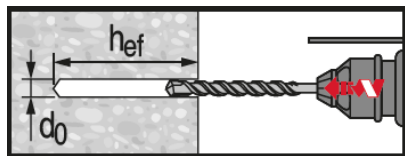

Hammer drilled hole (HD)

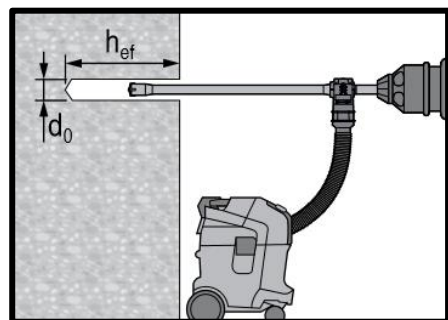

Hammer drilled hole with Hollow Drilled Bit (HDB)

No cleaning required

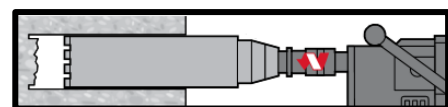

Diamond Drilling (DD)

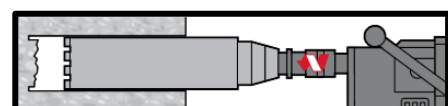

Diamond Drilling + Roughening Tool (DD+RT)

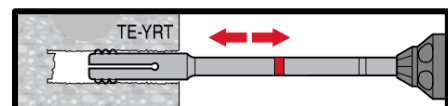

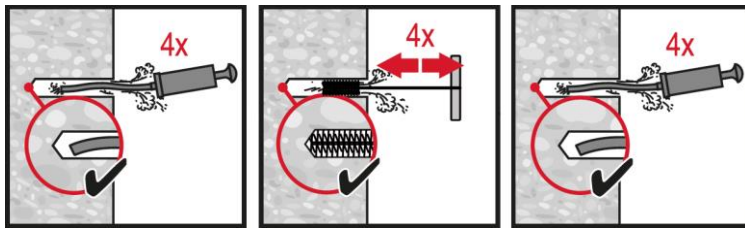

**Hammer Drilling:**

**Manual cleaning (MC)**

for drill diameters  $d_0 \leq 20$  mm and drill hole depth  $h_0 \leq 10 \cdot d$ .

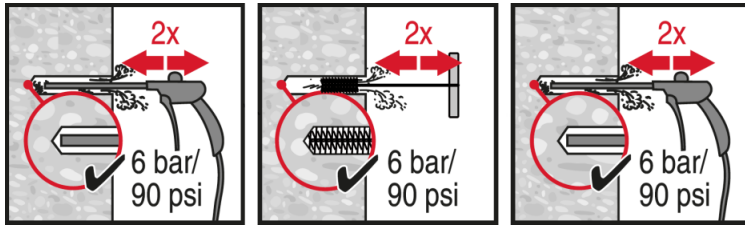

**Hammer Drilling:**

**Compressed air cleaning (CAC)**

for all drill hole diameters  $d_0$  and drill hole depths  $h_0 \leq 20 \cdot d$ .

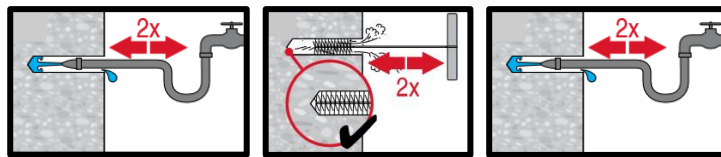

**Diamond cored holes:**

**Compressed air cleaning (CAC)**

for all drill hole diameters  $d_0$  and drill hole depths  $h_0$ .

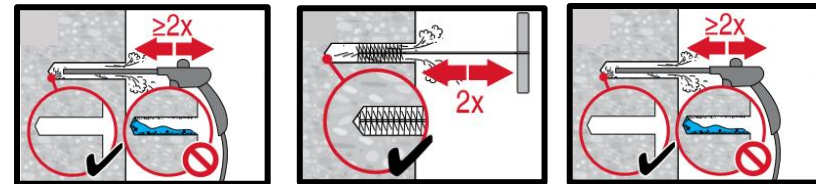

**Diamond cored holes with Hilti roughening tool:**

**Compressed air cleaning (CAC)**

for all drill hole diameters  $d_0$  and drill hole depths  $h_0$ .

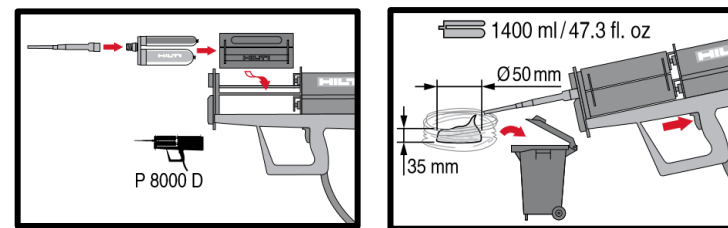
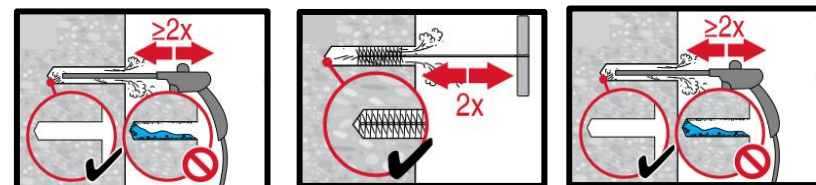

**Injection system preparation.**

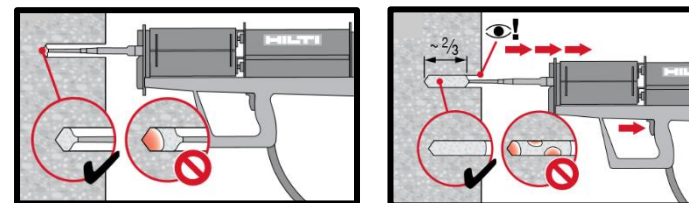

**Injection method for drill hole depth**

$h_{ef} \leq 250$  mm.

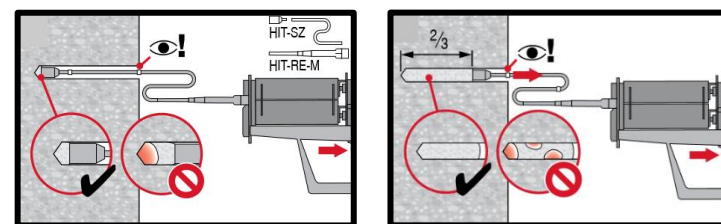

**Injection method for drill hole depth**

$h_{ef} > 250$  mm.

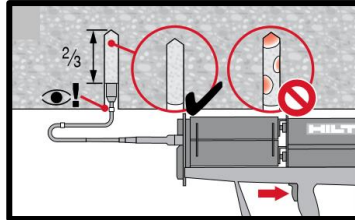
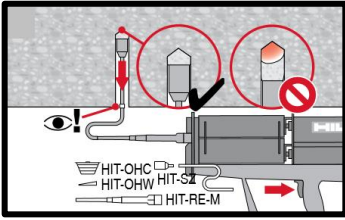

**Injection** method for overhead application.

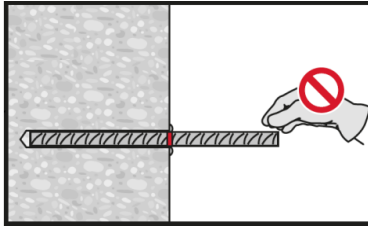
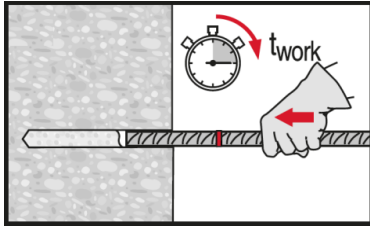

**Setting element**, observe working time " $t_{work}$ ".

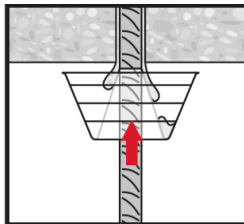
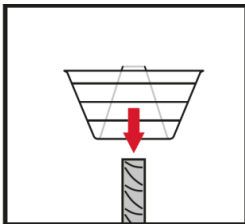
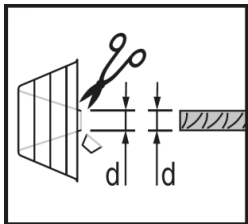

**Setting element** for overhead applications, observe working time " $t_{work}$ ".

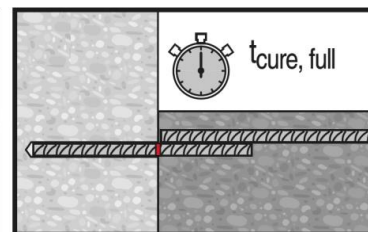
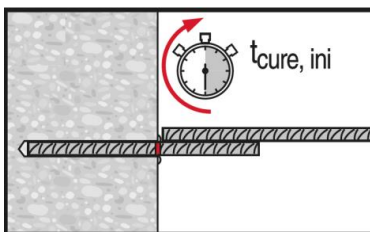
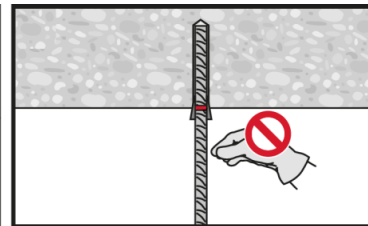
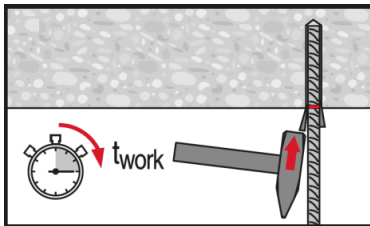

Apply full load only after curing time " $t_{cure}$ ".

